



ALUMINUM PROFILE 2022



PRODUCTS & SERVICES

We offer wide range of

LED Strip Lights

SMD5050,SMD3528,SMD2835,
SMD3014,SMD5630,SMD2216
Series Led strip lights.

LED Linear Lights

There are few types of led linear lights, but we can help you assemble linear lights according to your request.

LED Aluminum Profiles

surface-mounted, Recessed, Pendant,
Corner, Round, Stair, Flexible styles.

OEM ODM Service

OEM ODM Service is welcome.
We offering several services to meet different clients's requirement.



Lightstec is China-based Led Strip Lights, Led Aluminum Profiles and Led Linear Lights Manufacturer & Factory Since 2008.

Lightstec® is a LED Strip Light, LED Linear light system, LED Aluminum Profile manufacturer factory which founded in 2008. We have our own factory and R&D Dept. Local in Guangdong, China. Near Hong Kong, Shenzhen and Guangzhou.

We mainly focus on Designing, producing and shipping High quality LED lighting products. All of our LED Products are produced by a team of skilled crafts people and manufacture from the finest materials available. Each finished piece is meticulously inspected and packaged to ensure delivery of only the highest quality product to the customer. Our quality and design are supported by our considerate customer service.

Customer satisfaction is our primary goal and we will work hard to accommodate any request and to serve our clients at the highest level possible. No matter you are an Architects, Dealers, Designers or Corporate Buyers, Wholesaler. We will serve you with the same level of care and quality products.

Welcome to our factory!



PROFILE STRUCTURE

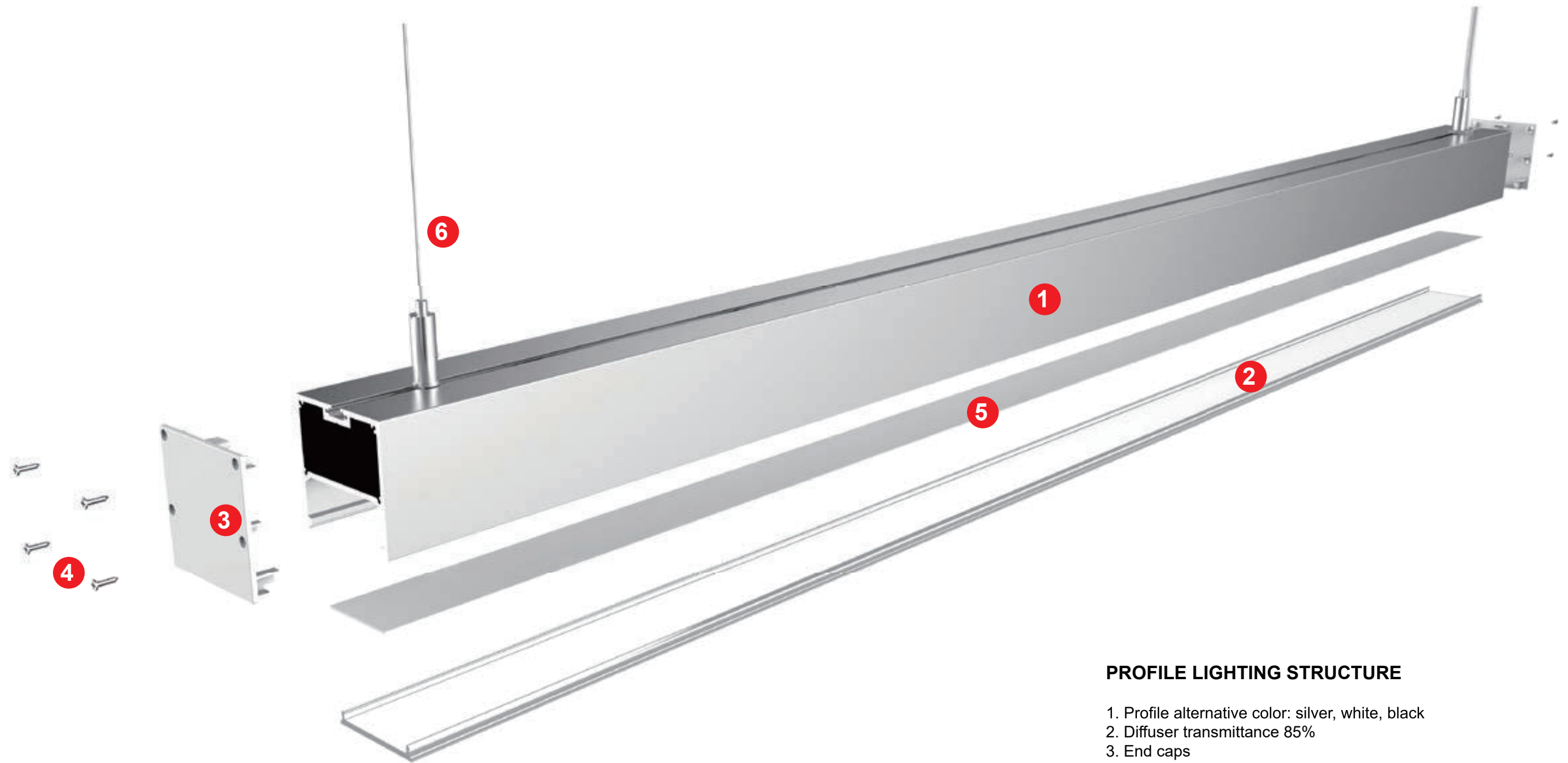

PROFILE LIGHTING STRUCTURE

1. Profile alternative color: silver, white, black
2. Diffuser transmittance 85%
3. End caps
4. Screws
5. Light source
6. Accessories

PROFILE INSTALLATION

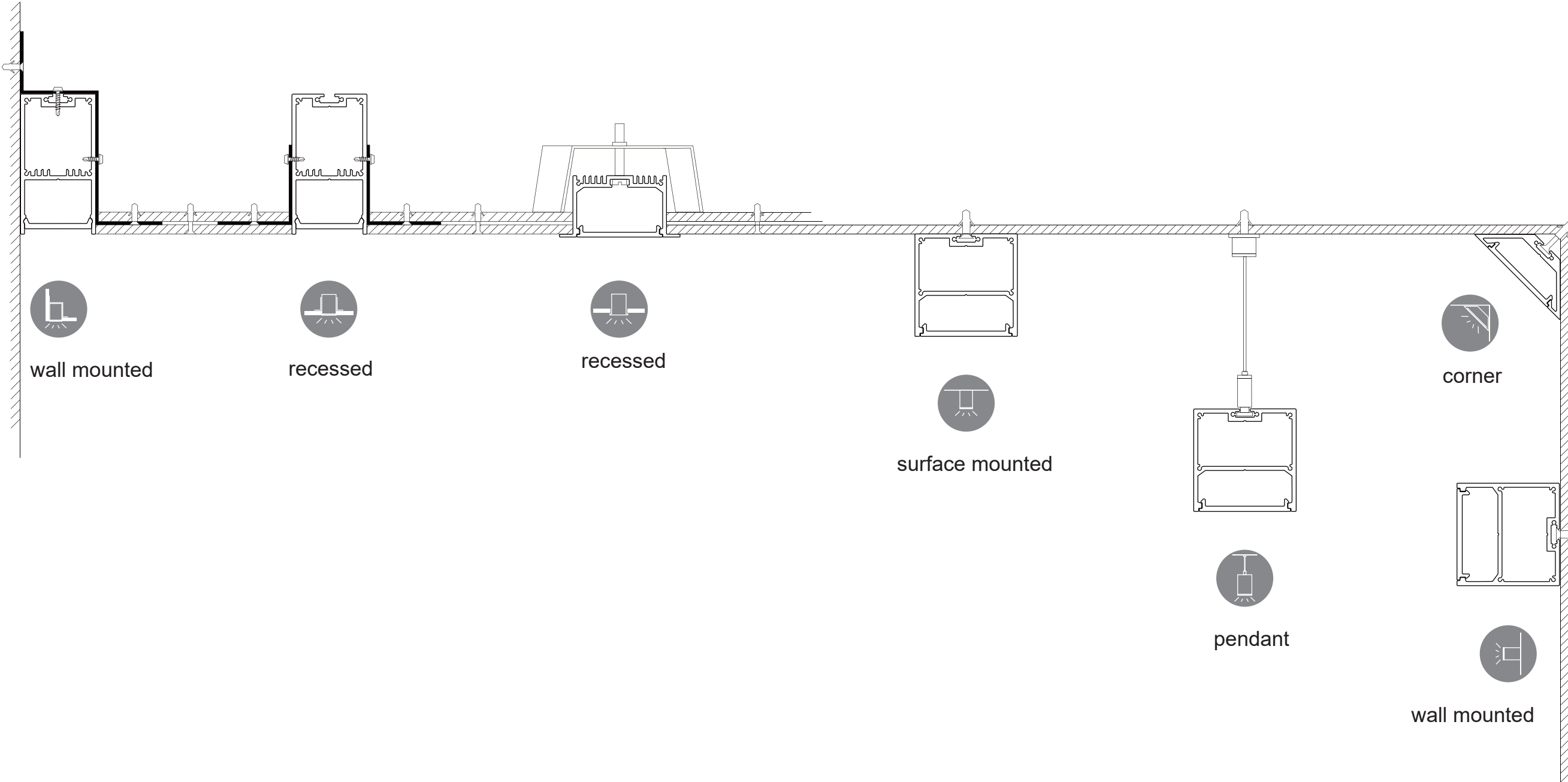

Linear Light Installation

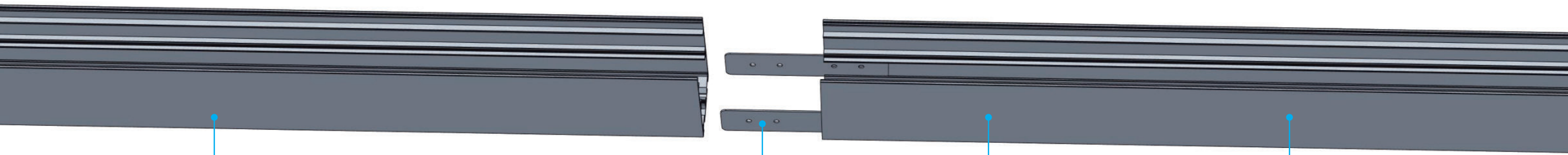
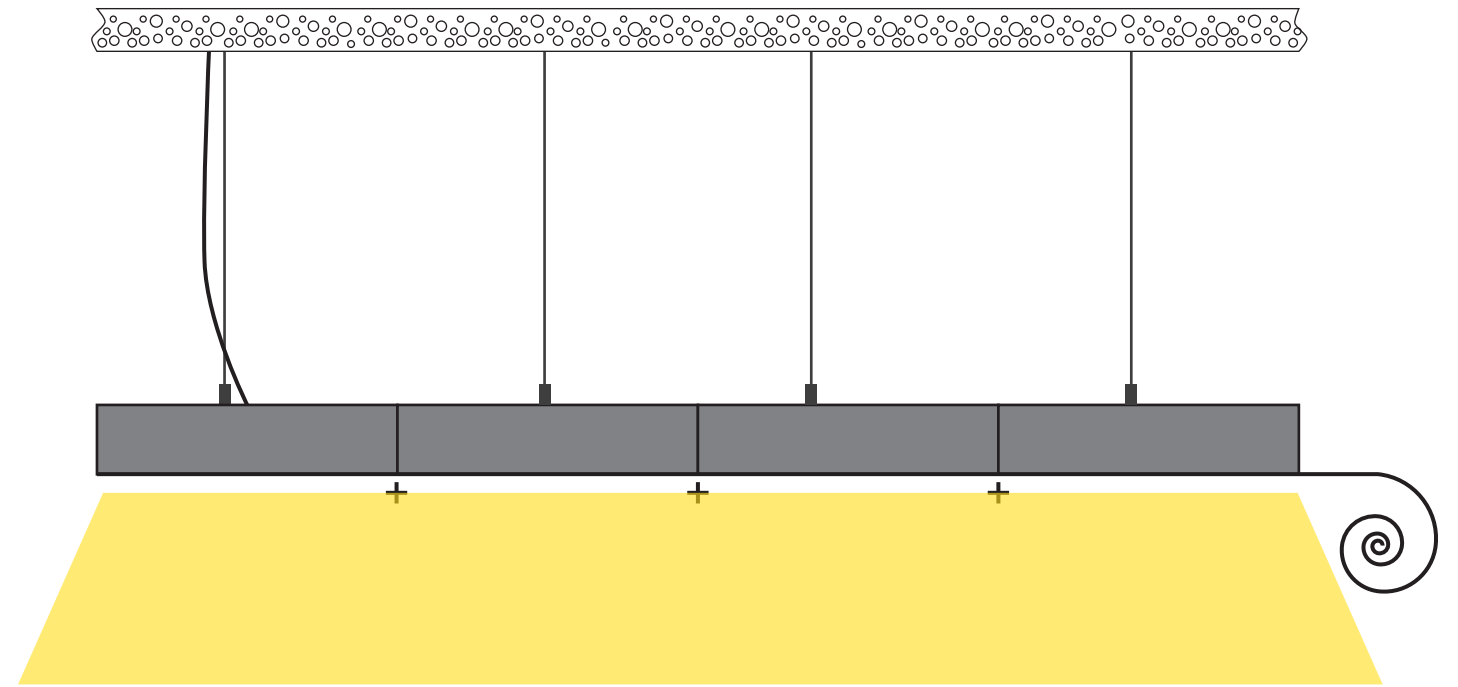
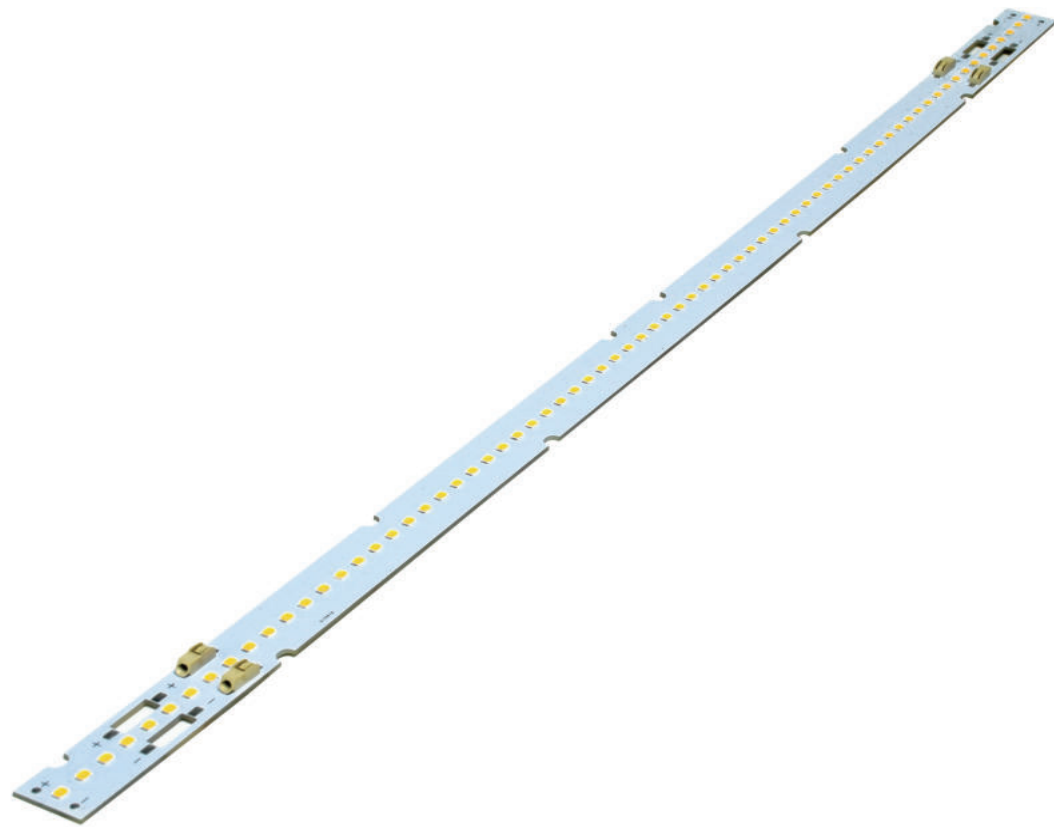

Profile1

Connector x2pcs

Profile2

LED driver Inside

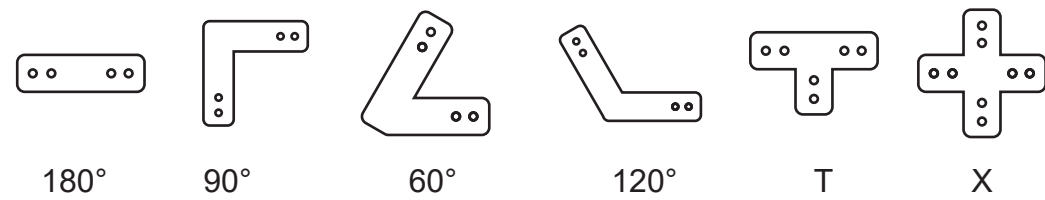

ALUMINUM PROFILE

Office Lighting

Professional

P01-P09

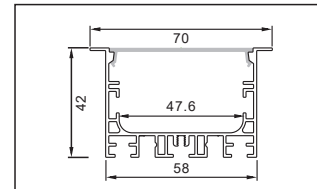

5842A/03

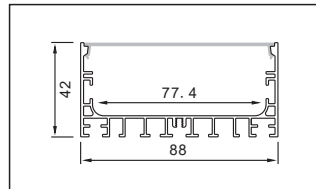

8842M/06

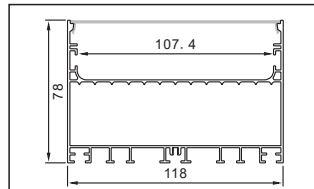

11878M/08

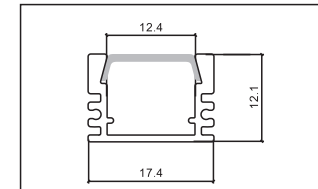

505/11

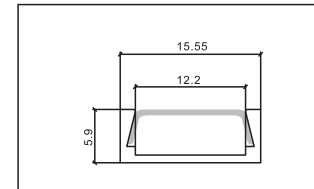

610/13

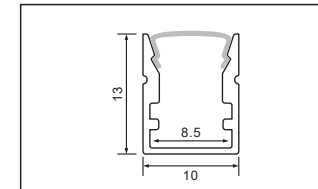

624/15

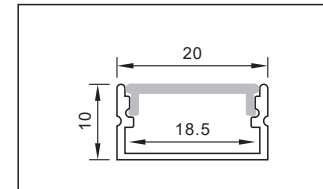

2010M/17

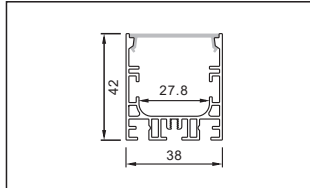

3842M/02

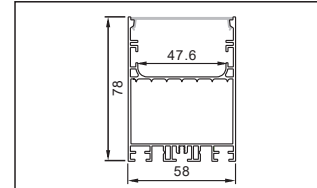

5878M/04

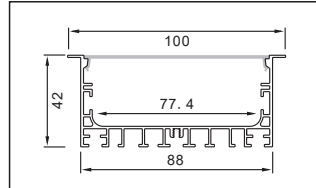

8842A/06

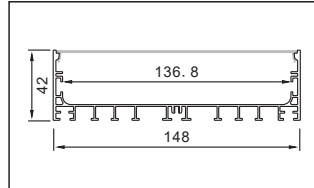

14842M/08



508/11

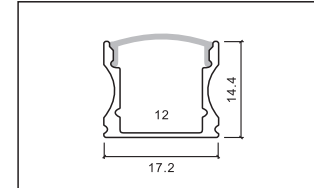

613/13

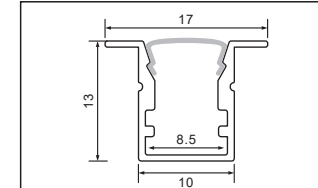

624A/15

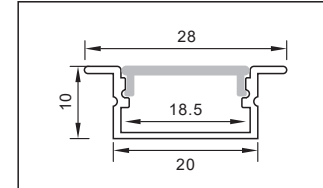

2010A/17

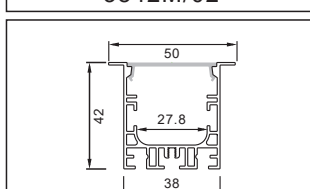

3842A/02

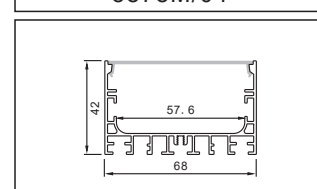

6842M/04

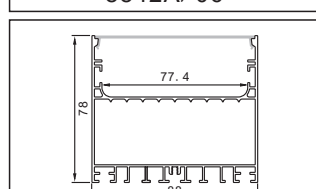

8878M/06

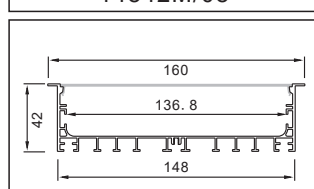

14842A/08

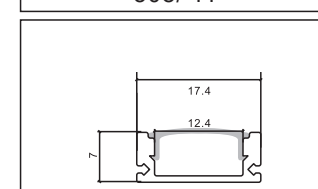

509/11

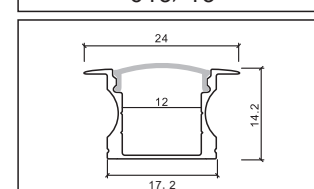

613B13

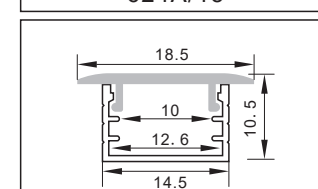

MA-1/15

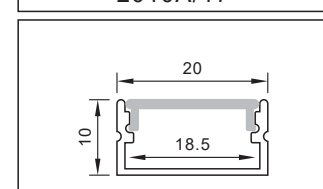

2010M-L/17

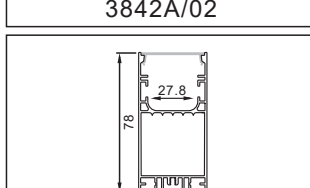

3878M/02

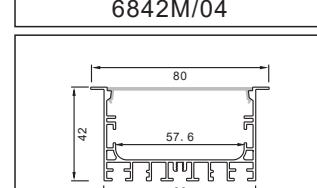

6842A/04

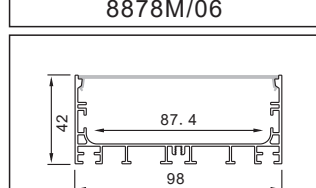

9842M/06

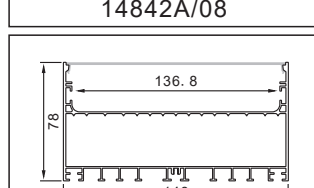

14878M/09

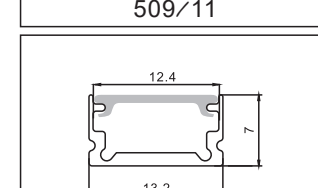

510/11

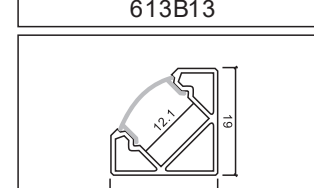

614/13

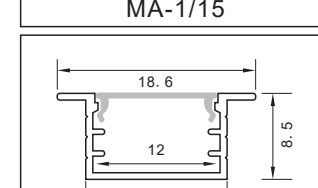

1409A/15

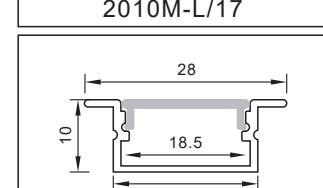

2010A-L/18

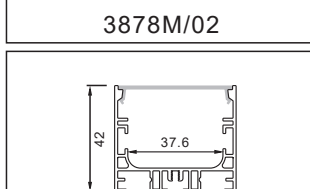

4842M/02

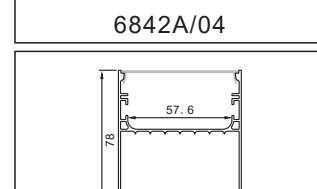

6878M/04

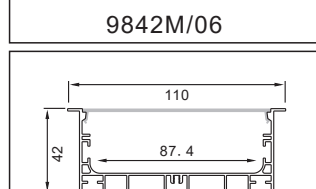

9842A/07

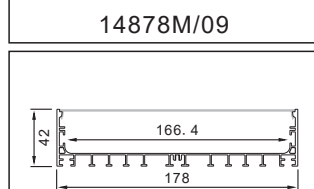

17842M/09

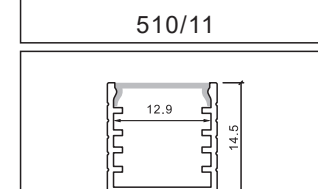

524/12

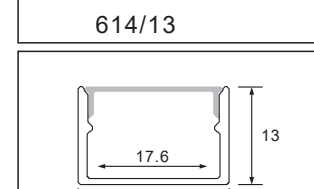

616/14

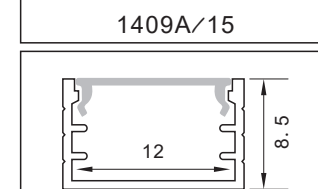

1409M/16

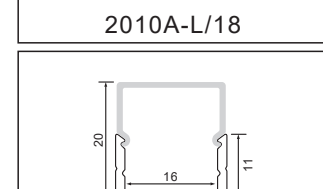

2011/18

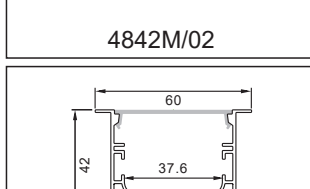

4842A/03

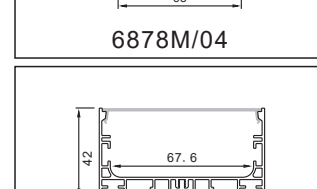

7842M/05

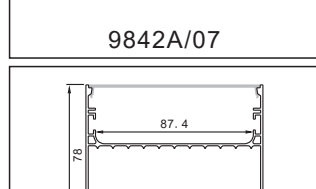

9878M/07

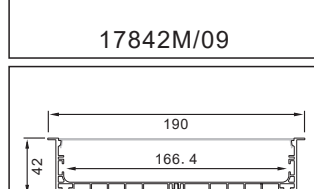

17842A/09

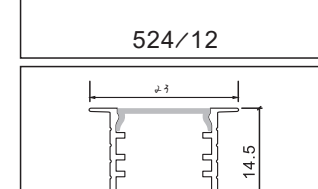

524A/12

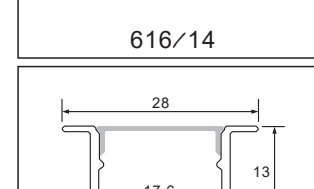

616A/14

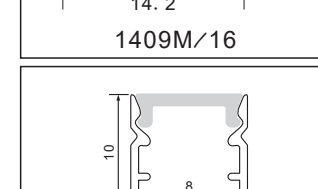

1010M/16

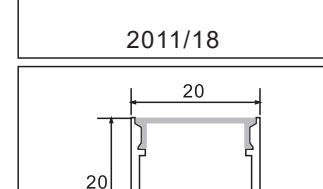

2020M/18

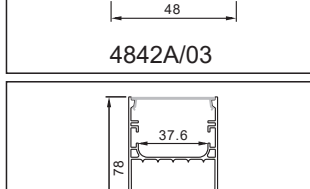

4878M/03

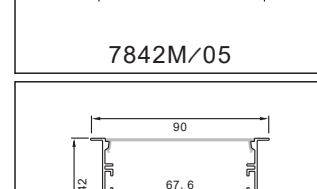

7842A/05

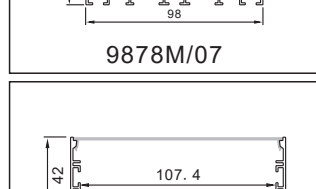

11842M/07

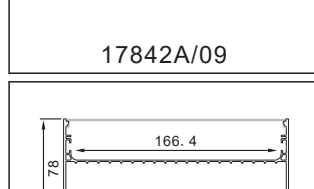

17878M/09

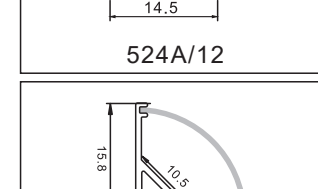

601/12

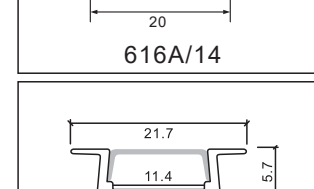

618/14

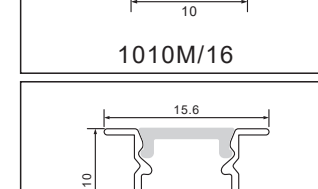

1010A/16

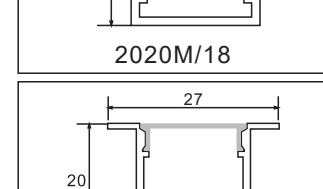

2020A/18

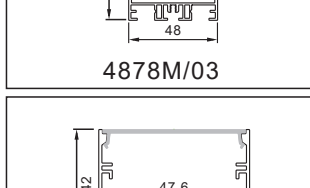

5842M/03

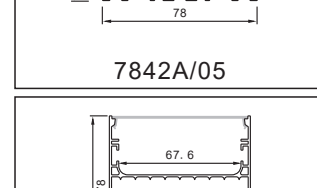

7878M/05

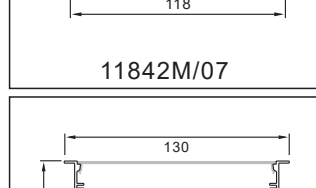

11842A/08

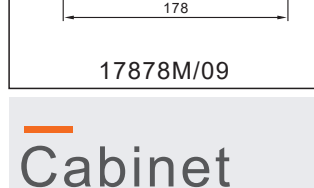

605/12

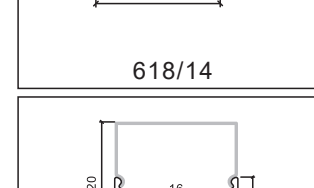

623/14

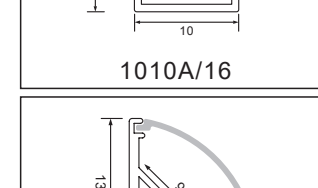

1313/16

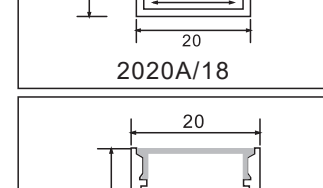

2020M-L/19

Cabinet Profile

P10-P20

ALUMINUM PROFILE

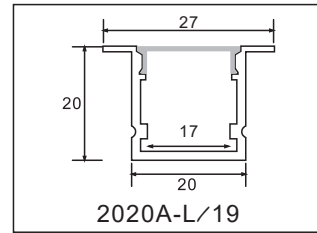

2020A-L/19

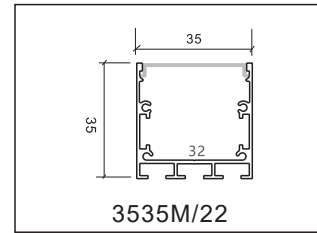

3535M/22

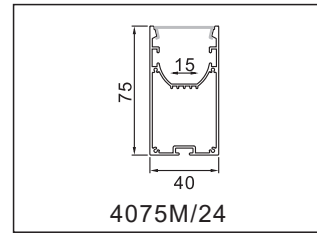

4075M/24

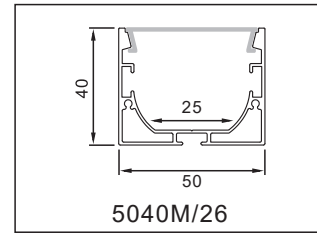

5040M/26

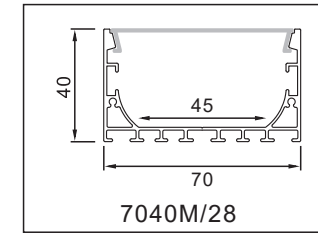

7040M/28

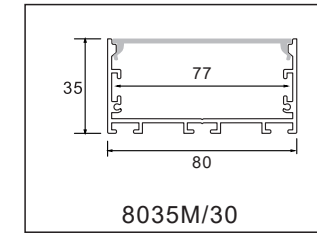

8035M/30

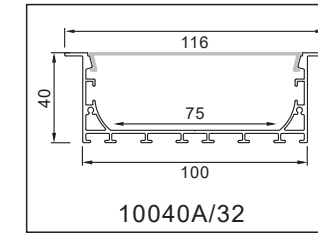

10040A/32

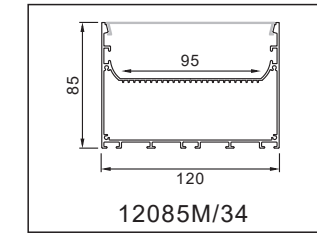

12085M/34

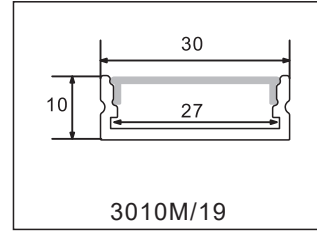

3010M/19

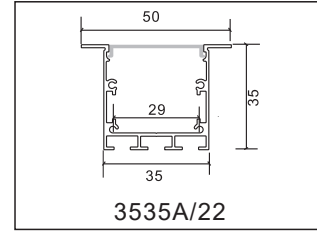

3535A/22

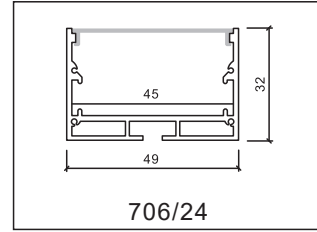

706/24

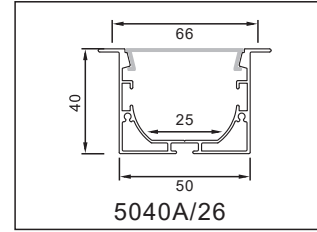

5040A/26

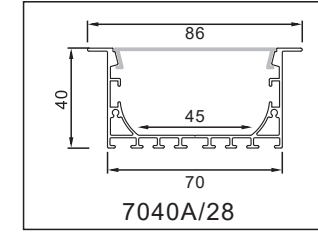

7040A/28

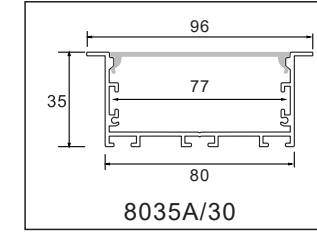

8035A/30

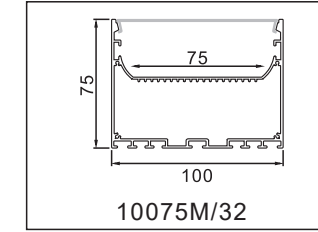

10075M/32

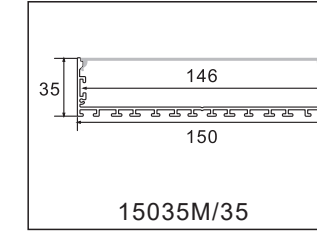

15035M/35

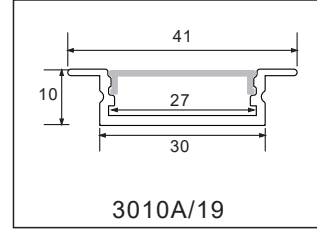

3010A/19

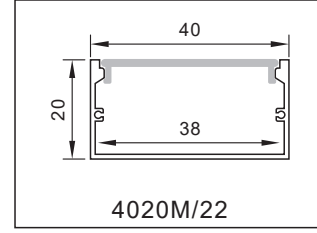

4020M/22

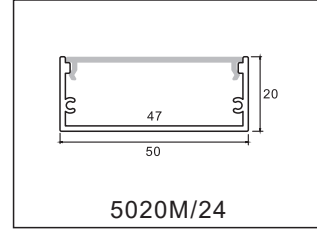

5020M/24

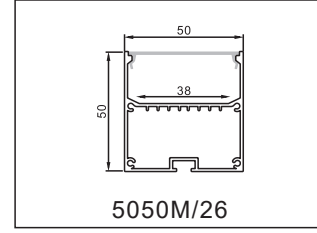

5050M/26

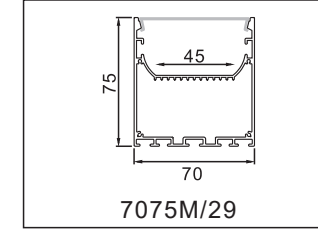

7075M/29

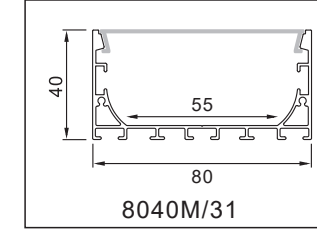

8040M/31

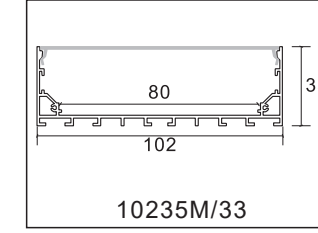

10235M/33

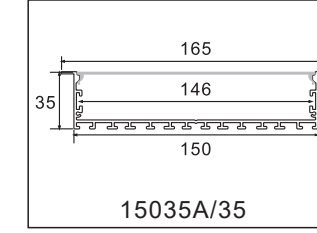

15035A/35

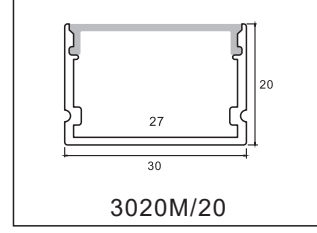

3020M/20

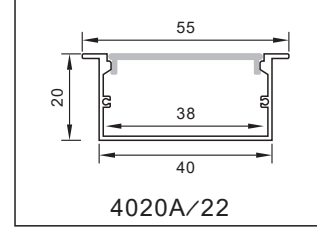

4020A/22

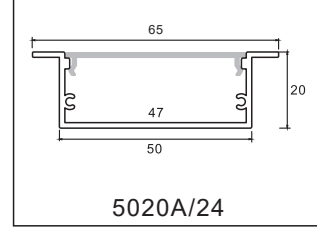

5020A/24

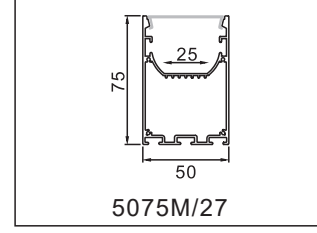

5075M/27

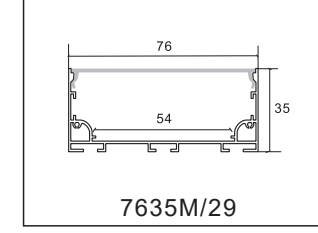

7635M/29

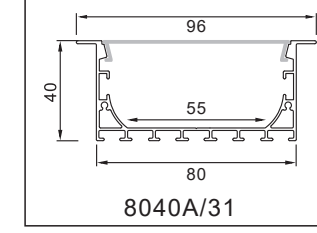

8040A/31

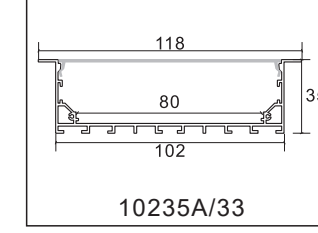

10235A/33

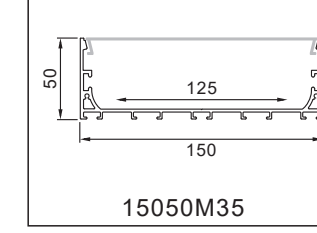

15050M35

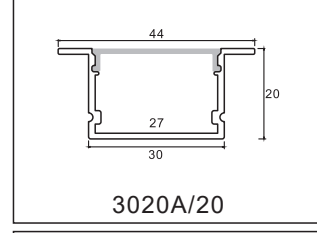

3020A/20

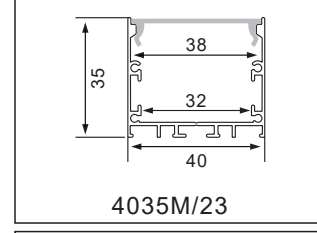

4035M/23

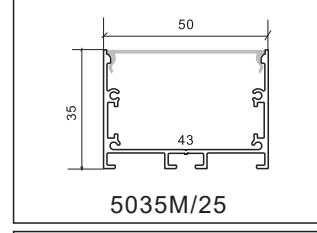

5035M/25

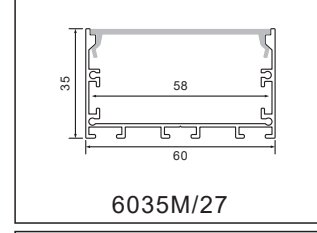

6035M/27

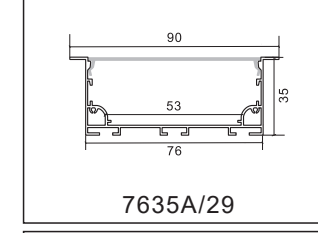

7635A/29

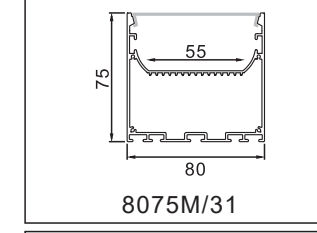

8075M/31

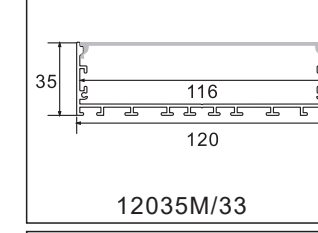

12035M/33

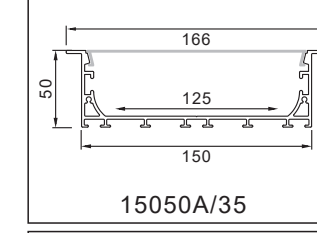

15050A/35

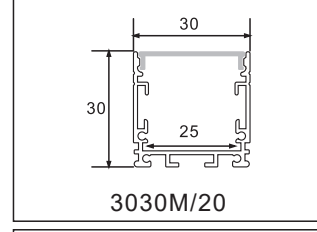

3030M/20

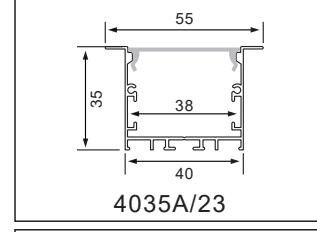

4035A/23

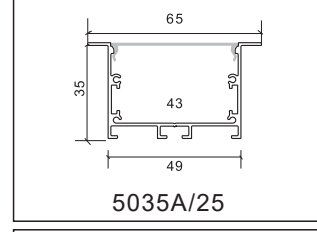

5035A/25

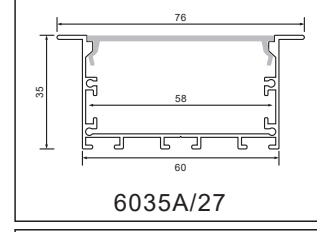

6035A/27

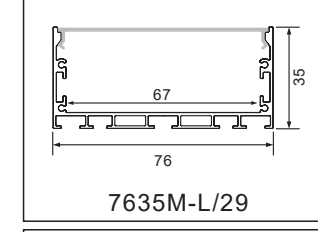

7635M-L/29

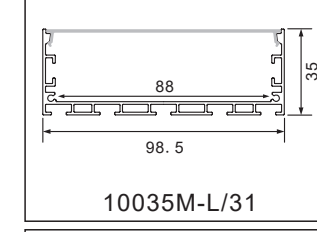

10035M-L/31

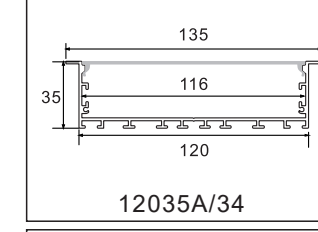

12035A/34

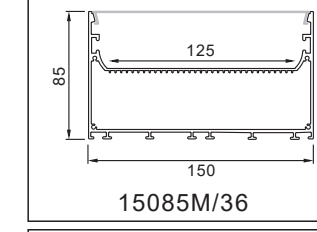

15085M/36

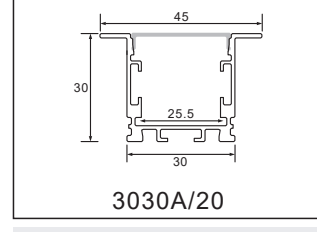

3030A/20

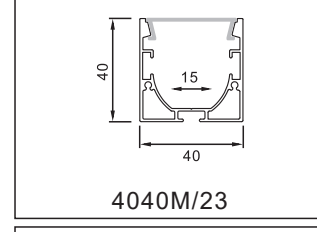

4040M/23

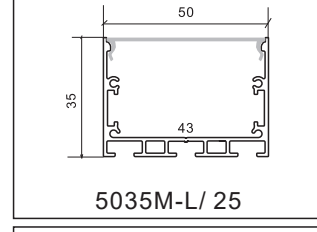

5035M-L/ 25

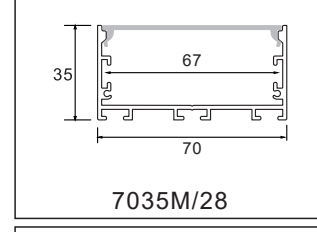

7035M/28

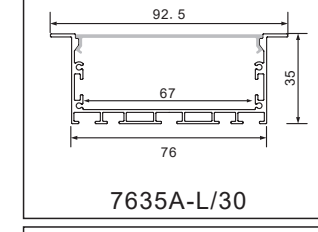

7635A-L/30

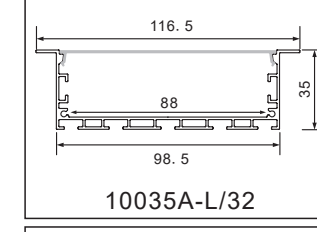

10035A-L/32

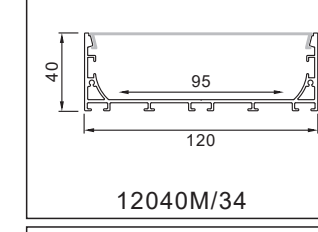

12040M/34

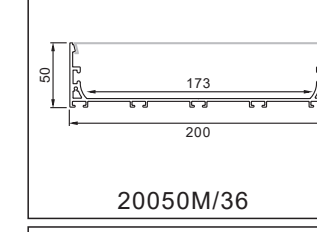

20050M/36

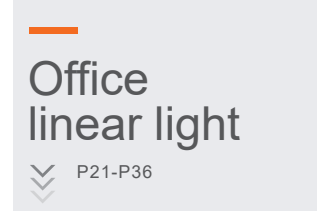

4040A/23

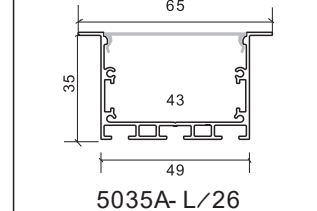

5035A- L/26

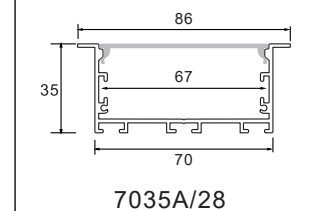

7035A/28

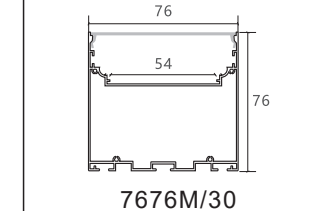

7676M/30

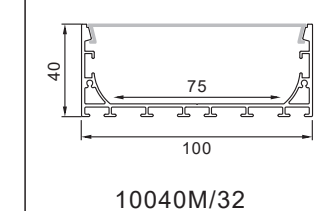

10040M/32

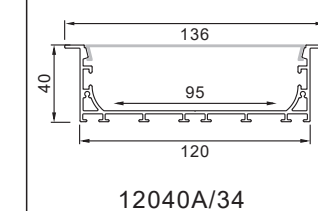

12040A/34

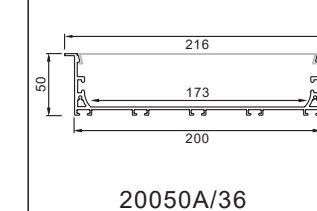

20050A/36

Office
linear light

P21-P36

ALUMINUM PROFILE

Up and Down LED

P37-P38

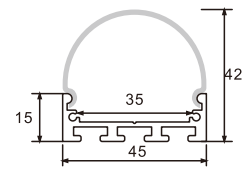

4542R/40

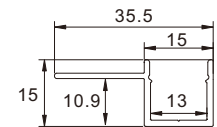

701/43

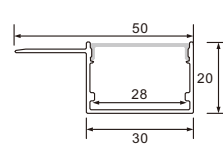

3020/46

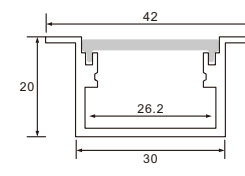

3020A/49

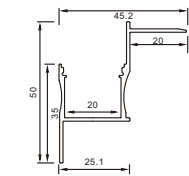

103/52

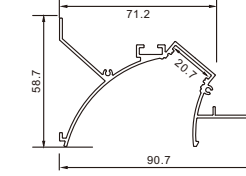

54

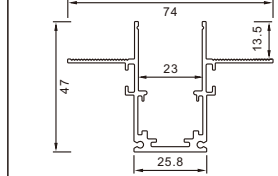

CX-01/57

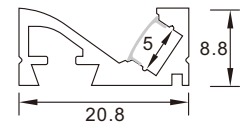

2109M/38

Drywall

P41-P46

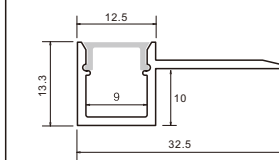

704/42

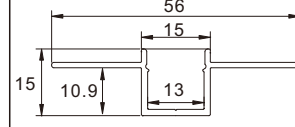

639/44

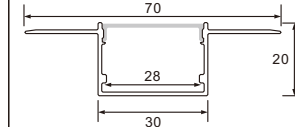

3020/46

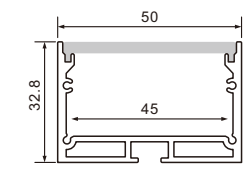

5032M/49

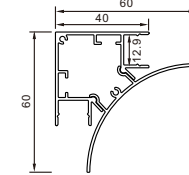

104/52

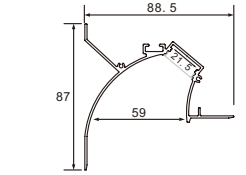

55

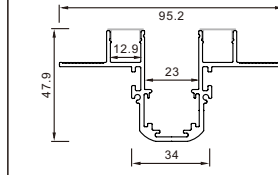

58

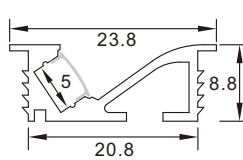

2109A/38

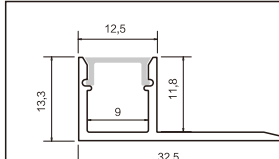

702/42

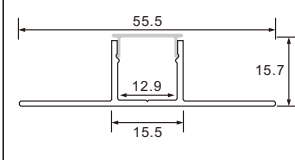

639/44

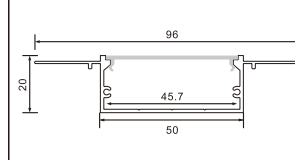

9620/46

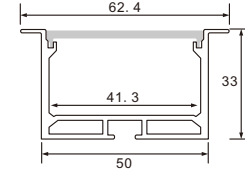

5032A/49

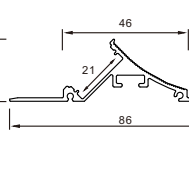

105/53

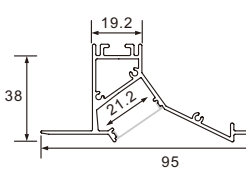

802/55

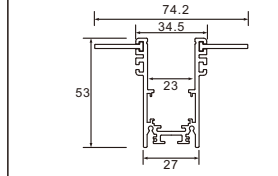

58

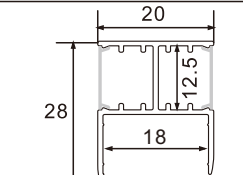

2028/38

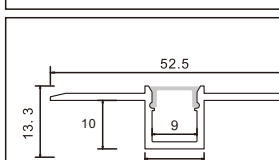

702/42

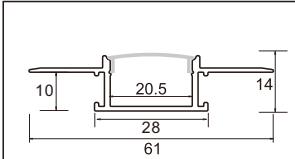

6114/44

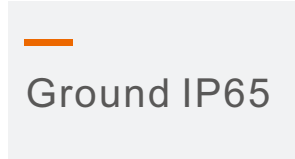

9620/46

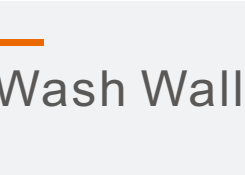

5032A/49

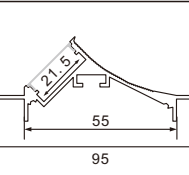

801/53

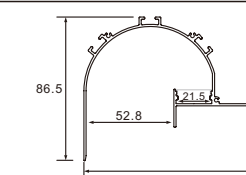

55

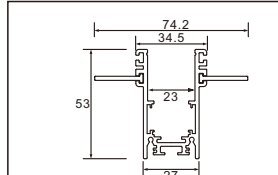

58

3D

P39-P40

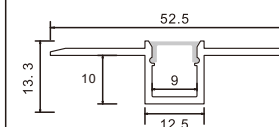

639/42

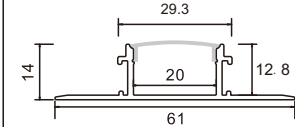

6114A/44

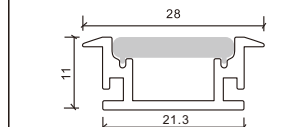

632-1/48

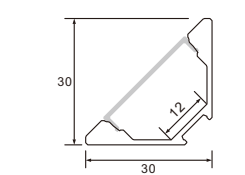

3030-L/51

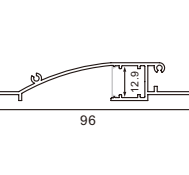

803/53

Magnet

P56-P61

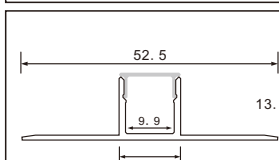

703/42

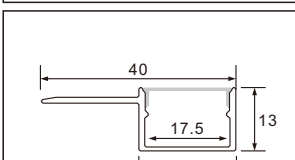

2013/45

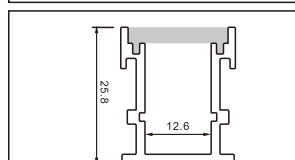

632/48

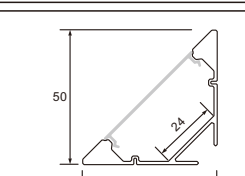

5050-L/51

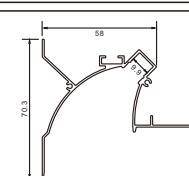

106/54

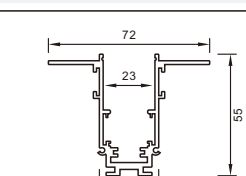

2. 0/57

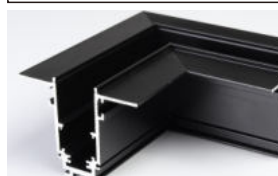

90/59

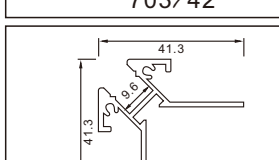

707M/43

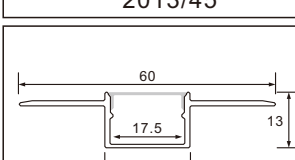

2013/45

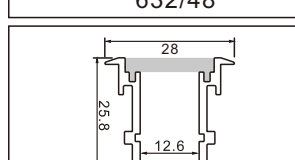

632A/48

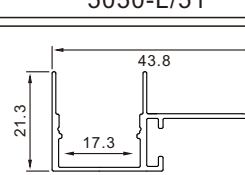

101/51

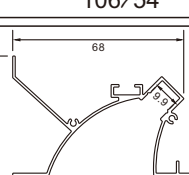

107/54

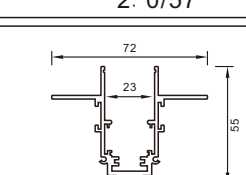

2. 0/57



59

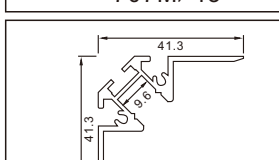

707A/43

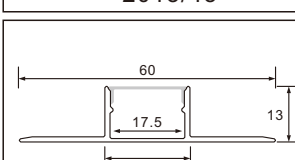

2013/45

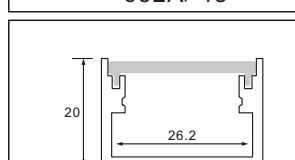

3020M/49

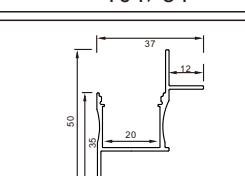

102/52

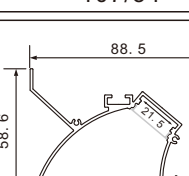

54

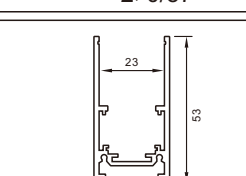

2. 0/57



60

Ground IP65

P47-49

Wash Wall

P50-P61

ALUMINUM PROFILE

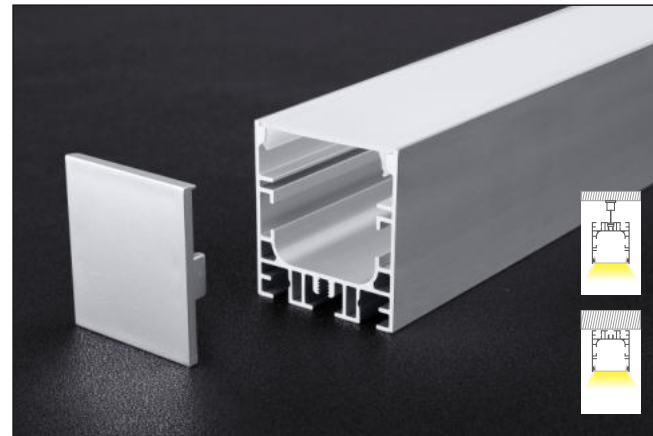

3842M

Description

size: Lx38x42mm
 Material: 6063-T5
 Surface: Silver / black / white Anodized
 PC cover: Milky white/black/acrylic matte
 Apply: LED Strips and PCB 20mm

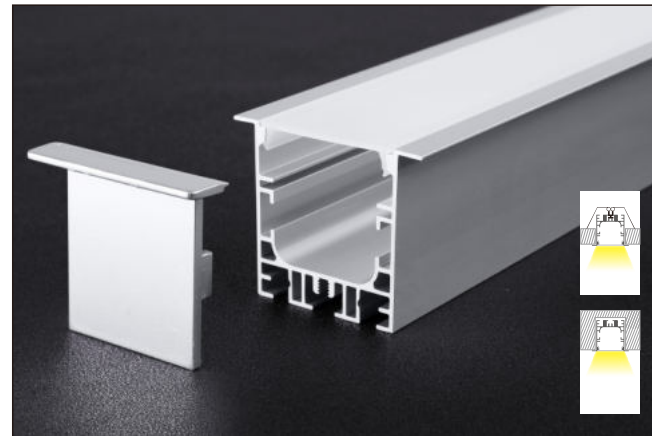
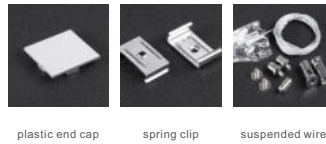
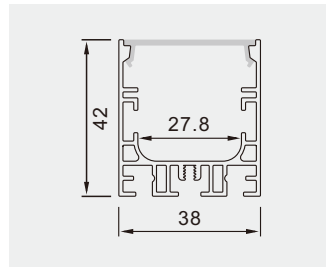

3842A

Description

size: Lx50x42mm
 Material: 6063-T5
 Surface: Silver / black / white Anodized
 PC cover: Milky white/black/acrylic matte
 Apply: LED Strips and PCB 20mm

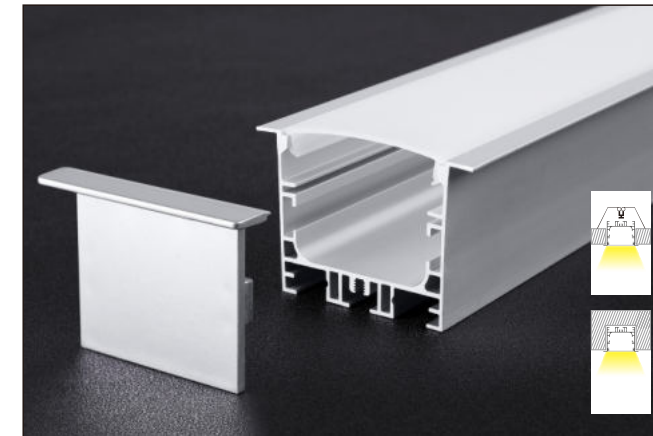
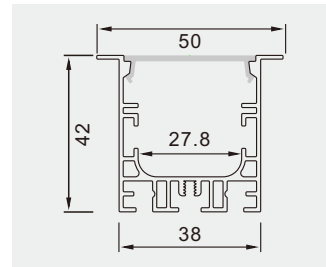

4842A

Description

size: Lx60x42mm
 Material: 6063-T5
 Surface: Silver / black / white Anodized
 PC cover: Milky white/black/acrylic matte
 Apply: LED Strips and PCB 30mm

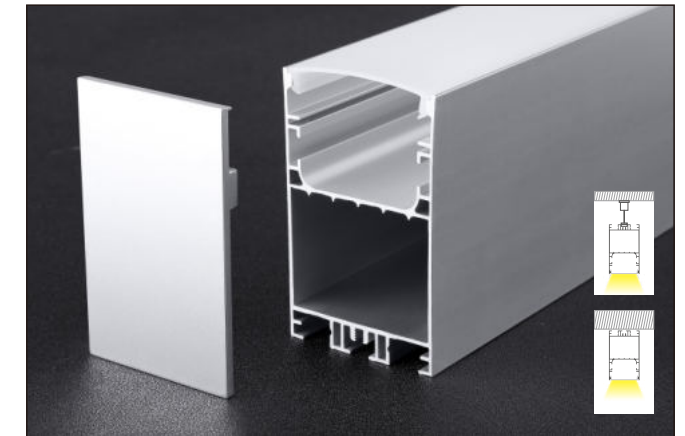
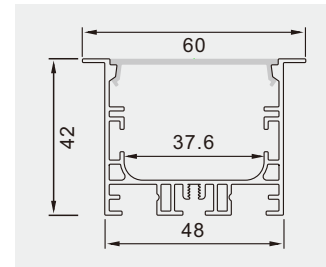

4878M

Description

size: Lx48x78mm
 Material: 6063-T5
 Surface: Silver / black / white Anodized
 PC cover: Milky white/black/acrylic matte
 Apply: LED Strips and PCB 30mm

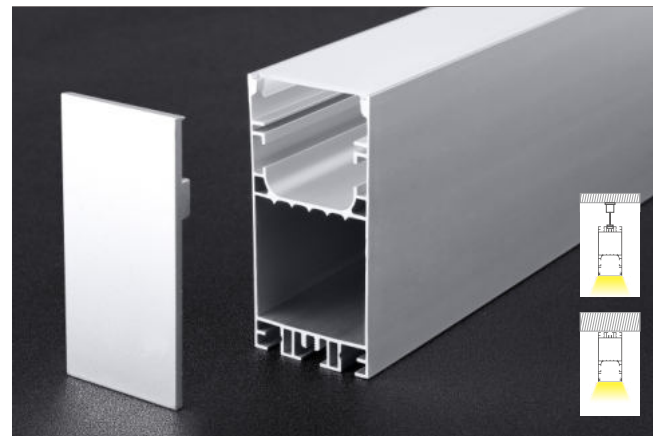
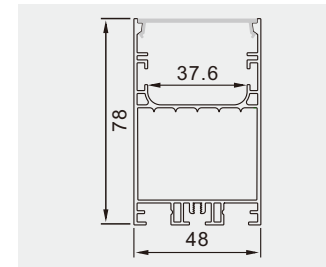

3878M

Description

size: Lx38x78mm
 Material: 6063-T5
 Surface: Silver / black / white Anodized
 PC cover: Milky white/black/acrylic matte
 Apply: LED Strips and PCB 20mm

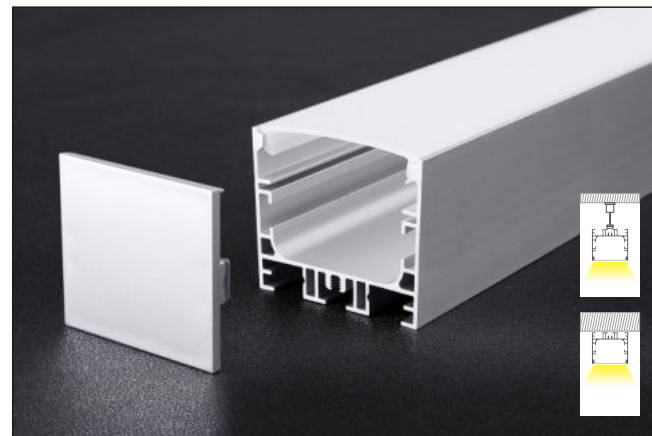
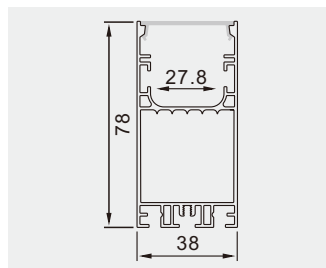

4842M

Description

size: Lx48x42mm
 Material: 6063-T5
 Surface: Silver / black / white Anodized
 PC cover: Milky white/black/acrylic matte
 Apply: LED Strips and PCB 30mm

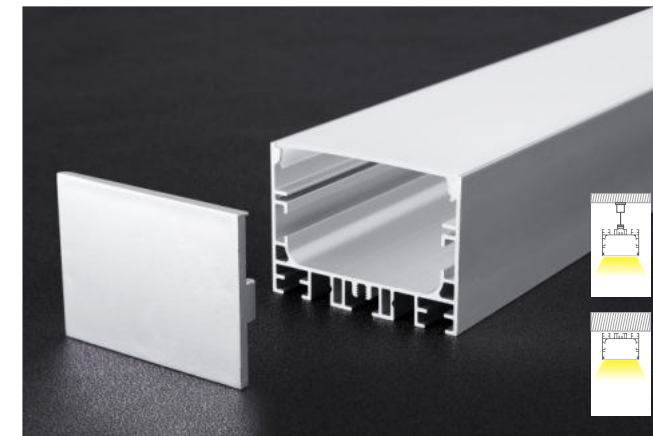
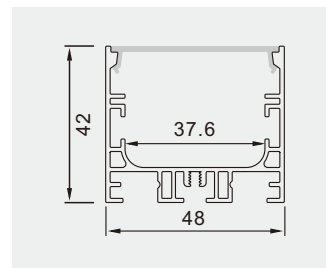

5842M

Description

size: Lx58x42mm
 Material: 6063-T5
 Surface: Silver / black / white Anodized
 PC cover: Milky white/black/acrylic matte
 Apply: LED Strips and PCB 40mm

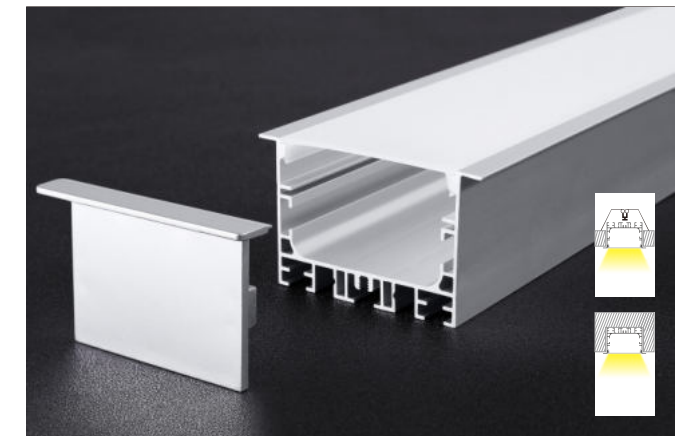
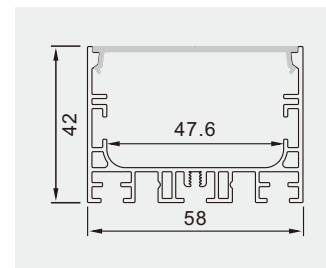

5842A

Description

size: Lx70x42mm
 Material: 6063-T5
 Surface: Silver / black / white Anodized
 PC cover: Milky white/black/acrylic matte
 Apply: LED Strips and PCB 40mm

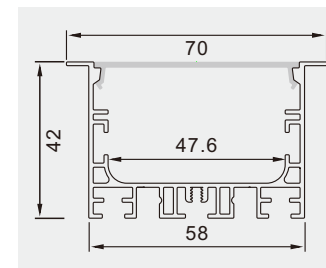

ALUMINUM PROFILE

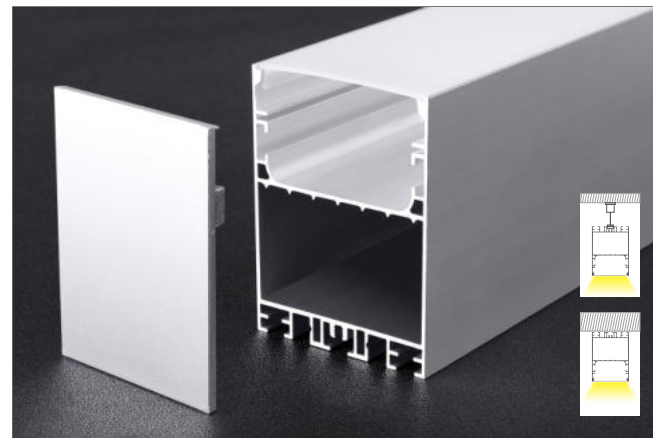

5878M

Description

size: Lx58x78mm
 Material: 6063-T5
 Surface: Silver / black / white Anodized
 PC cover: Milky white/black/acrylic matte
 Apply: LED Strips and PCB 40mm

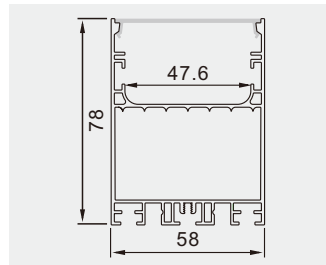

plastic end cap spring clip suspended wire

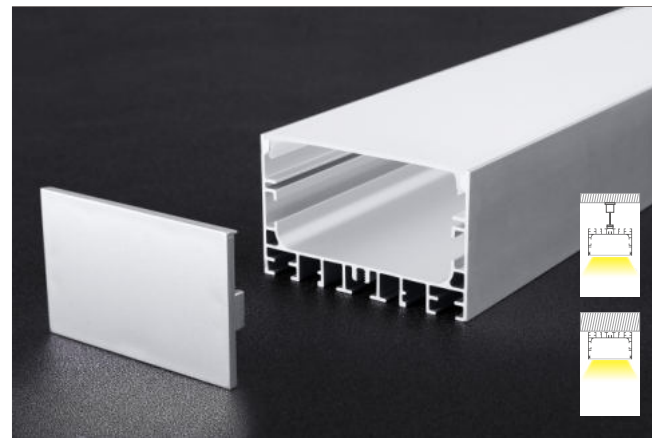

6842M

Description

size: Lx68x42mm
 Material: 6063-T5
 Surface: Silver / black / white Anodized
 PC cover: Milky white/black/acrylic matte
 Apply: LED Strips and PCB 50mm

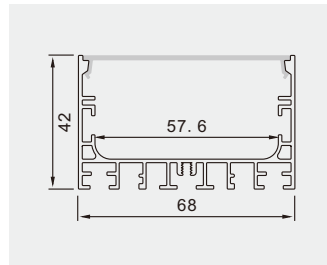

plastic end cap spring clip suspended wire

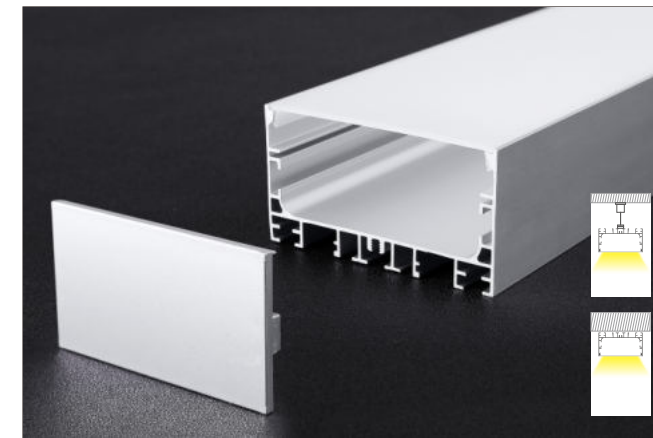

7842M

Description

size: Lx78x42mm
 Material: 6063-T5
 Surface: Silver / black / white Anodized
 PC cover: Milky white/black/acrylic matte
 Apply: LED Strips and PCB 60mm

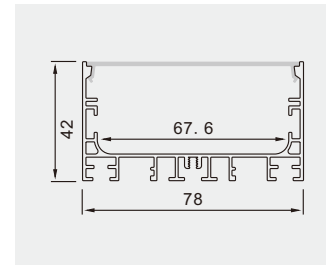

plastic end cap spring clip suspended wire



7842A

Description

size: Lx90x42mm
 Material: 6063-T5
 Surface: Silver / black / white Anodized
 PC cover: Milky white/black/acrylic matte
 Apply: LED Strips and PCB 60mm

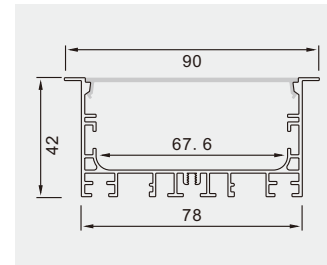

plastic end cap spring clip

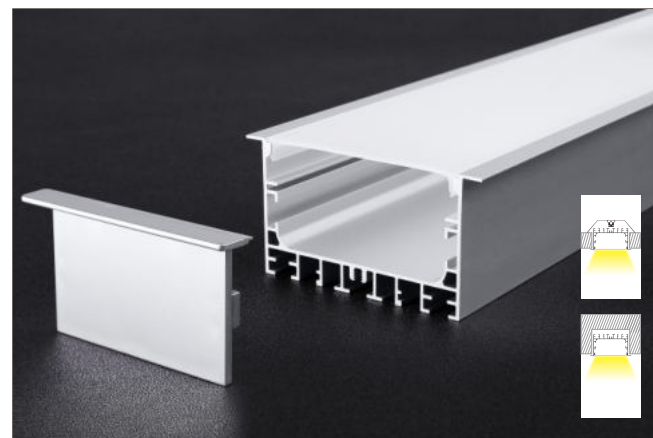

6842A

Description

size: Lx80x42mm
 Material: 6063-T5
 Surface: Silver / black / white Anodized
 PC cover: Milky white/black/acrylic matte
 Apply: LED Strips and PCB 50mm

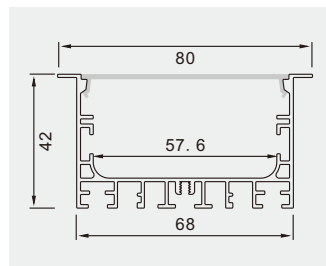

plastic end cap spring clip

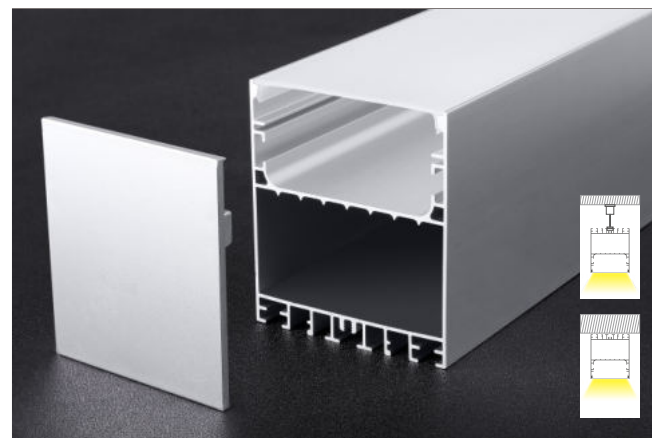

6878M

Description

size: Lx68x78mm
 Material: 6063-T5
 Surface: Silver / black / white Anodized
 PC cover: Milky white/black/acrylic matte
 Apply: LED Strips and PCB 50mm

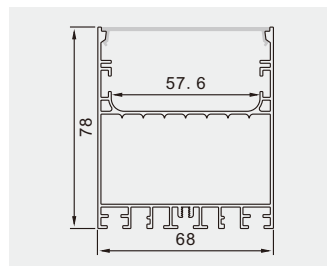

plastic end cap spring clip suspended wire

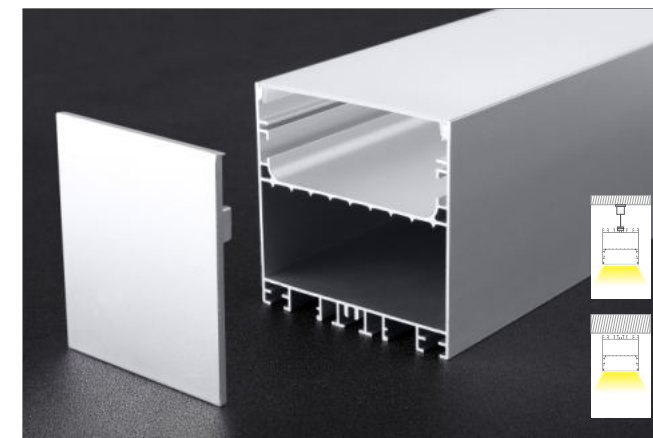

7878M

Description

size: Lx78x78mm
 Material: 6063-T5
 Surface: Silver / black / white Anodized
 PC cover: Milky white/black/acrylic matte
 Apply: LED Strips and PCB 60mm

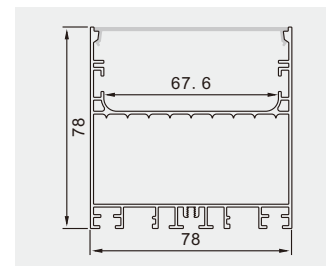

plastic end cap spring clip suspended wire

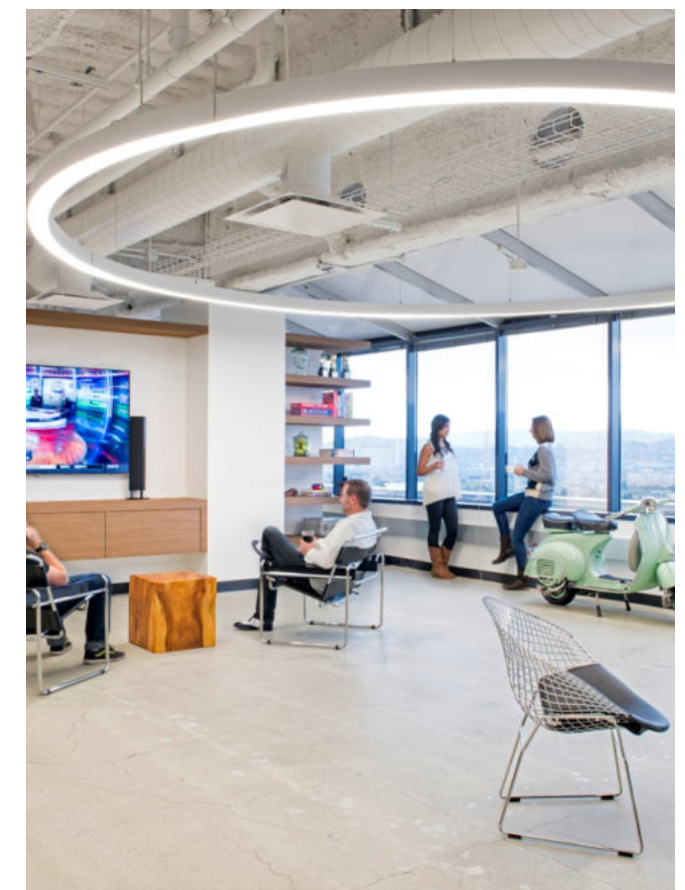

ALUMINUM PROFILE

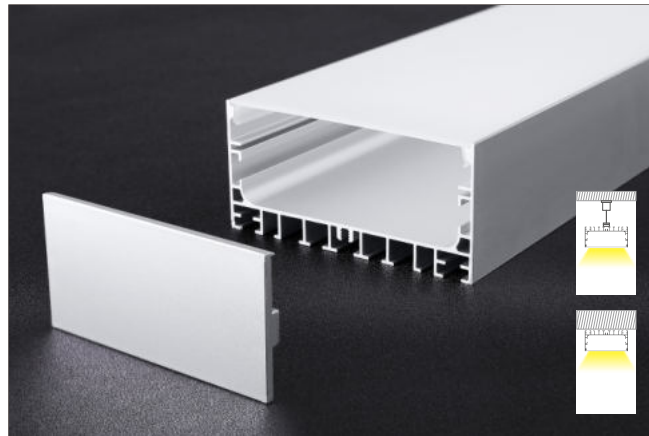

8842M

Description

size: Lx88x42mm
 Material: 6063-T5
 Surface: Silver / black / white Anodized
 PC cover: Milky white/black/acrylic matte
 Apply: LED Strips and PCB 70mm

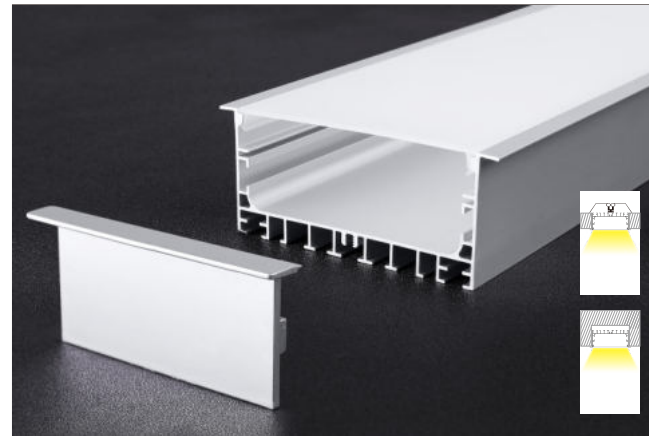
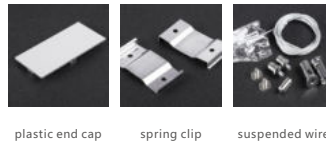
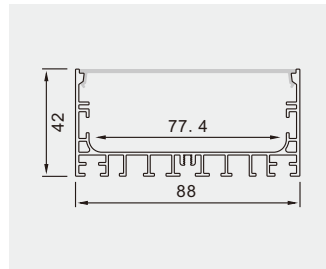

8842A

Description

size: Lx100x42mm
 Material: 6063-T5
 Surface: Silver / black / white Anodized
 PC cover: Milky white/black/acrylic matte
 Apply: LED Strips and PCB 70mm

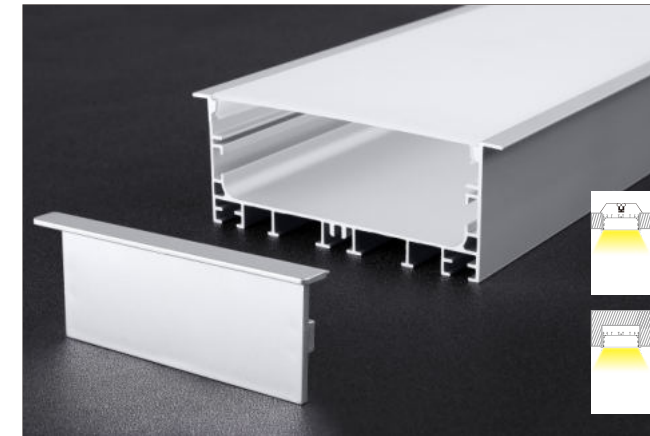
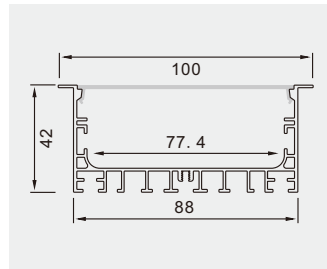

9842A

Description

size: Lx110x42mm
 Material: 6063-T5
 Surface: Silver / black / white Anodized
 PC cover: Milky white/black/acrylic matte
 Apply: LED Strips and PCB 80mm

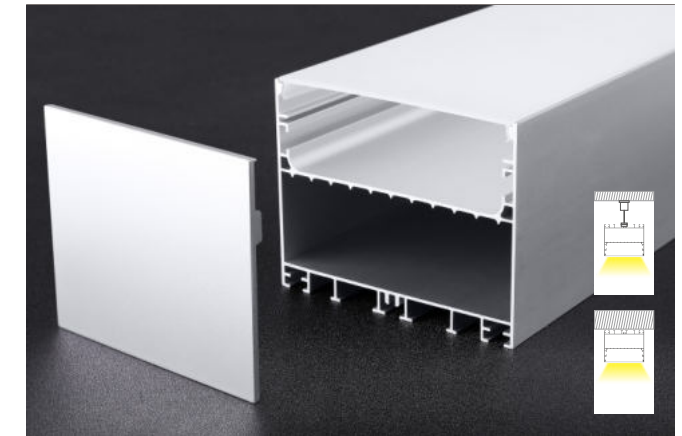
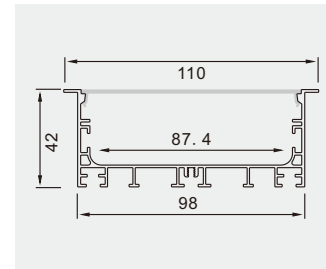

9878M

Description

size: Lx98x78mm
 Material: 6063-T5
 Surface: Silver / black / white Anodized
 PC cover: Milky white/black/acrylic matte
 Apply: LED Strips and PCB 80mm

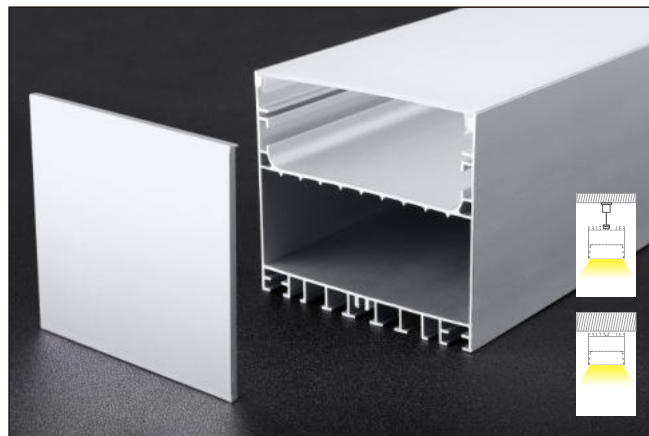
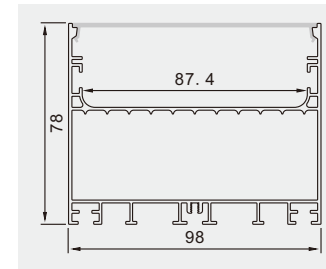

8878M

Description

size: Lx88x78mm
 Material: 6063-T5
 Surface: Silver / black / white Anodized
 PC cover: Milky white/black/acrylic matte
 Apply: LED Strips and PCB 70mm

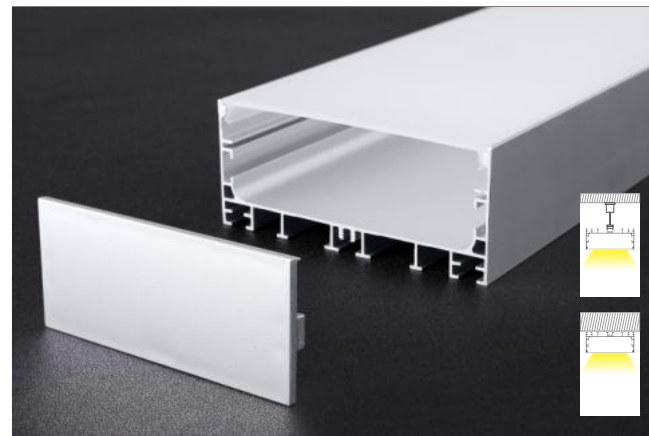
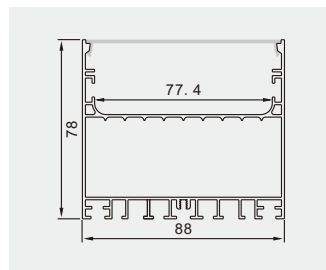

9842M

Description

size: Lx38x42mm
 Material: 6063-T5
 Surface: Silver / black / white Anodized
 PC cover: Milky white/black/acrylic matte
 Apply: LED Strips and PCB 80mm

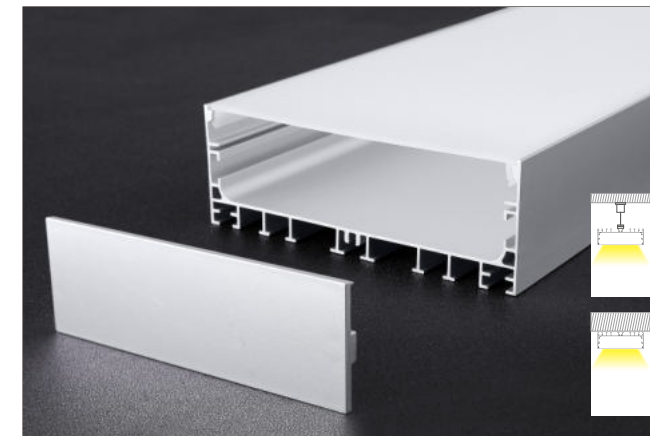
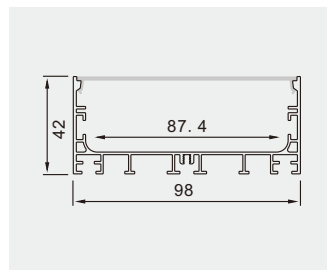

11842M

Description

size: Lx118x42mm
 Material: 6063-T5
 Surface: Silver / black / white Anodized
 PC cover: Milky white/black/acrylic matte
 Apply: LED Strips and PCB 100mm

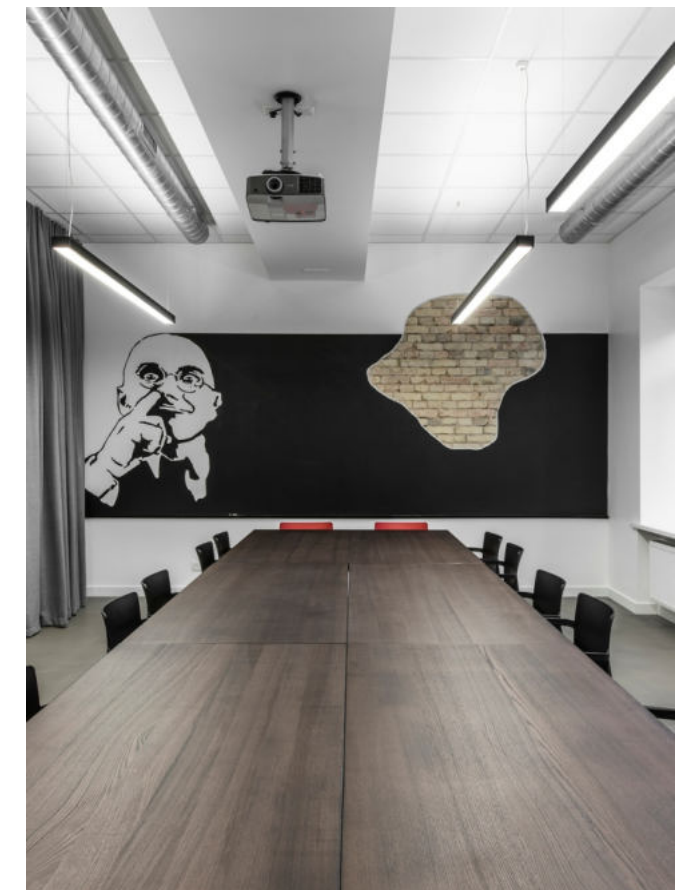
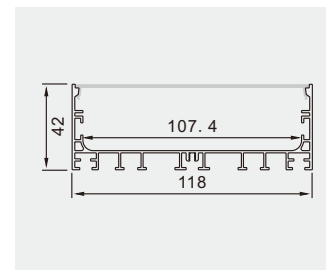

ALUMINUM PROFILE

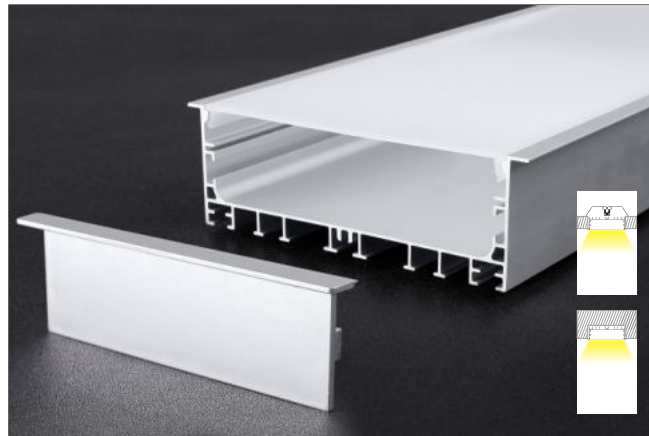

11842A

Description

size: Lx130x42mm
 Material: 6063-T5
 Surface: Silver / black / white Anodized
 PC cover: Milky white/black/acrylic matte
 Apply: LED Strips and PCB 100mm

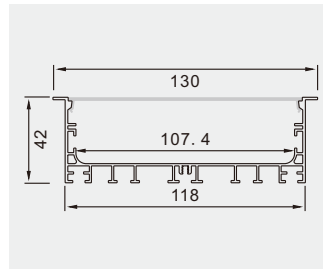

plastic end cap spring clip

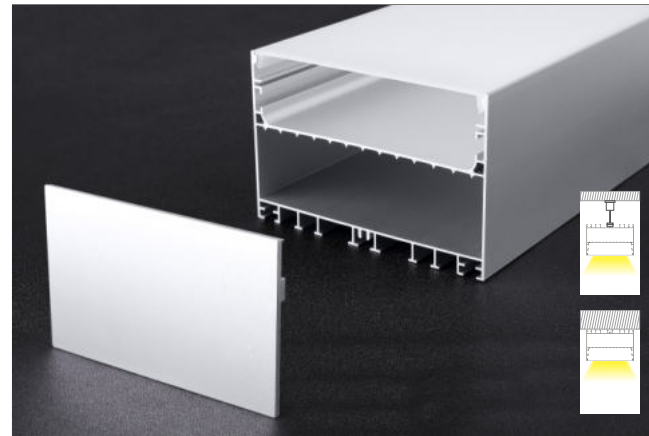

11878M

Description

size: Lx118x78mm
 Material: 6063-T5
 Surface: Silver / black / white Anodized
 PC cover: Milky white/black/acrylic matte
 Apply: LED Strips and PCB 100mm

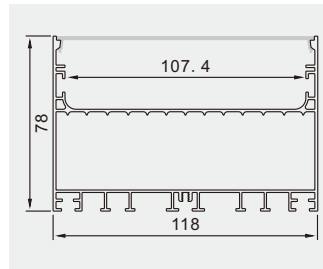

plastic end cap spring clip suspended wire

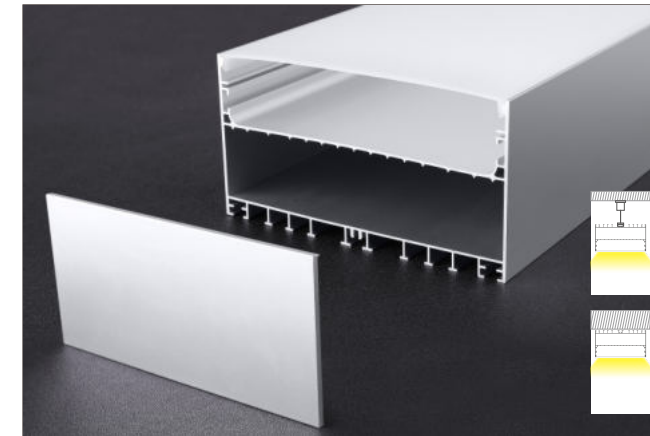

14878M

Description

size: Lx148x78mm
 Material: 6063-T5
 Surface: Silver / black / white Anodized
 PC cover: Milky white/black/acrylic matte
 Apply: LED Strips and PCB 120mm

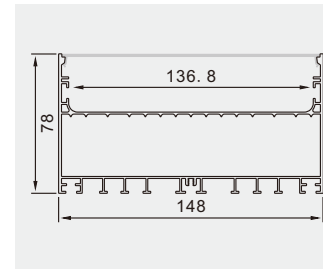

plastic end cap spring clip suspended wire



17842M

Description

size: Lx178x42mm
 Material: 6063-T5
 Surface: Silver / black / white Anodized
 PC cover: Milky white/black/acrylic matte
 Apply: LED Strips and PCB 150mm

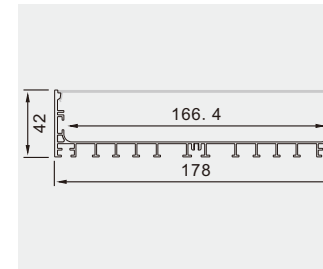

plastic end cap spring clip suspended wire

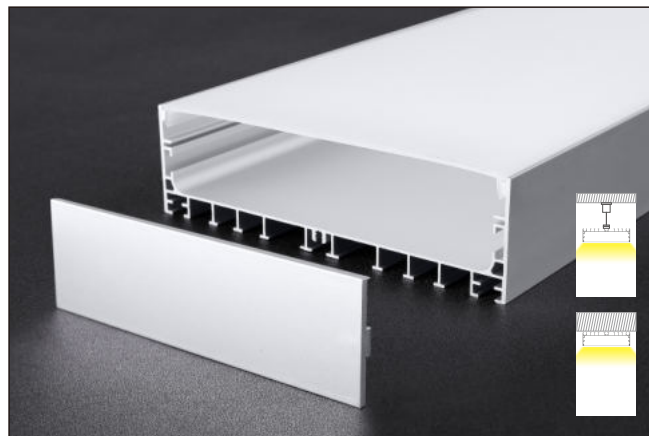

14842M

Description

size: Lx148x42mm
 Material: 6063-T5
 Surface: Silver / black / white Anodized
 PC cover: Milky white/black/acrylic matte
 Apply: LED Strips and PCB 120mm

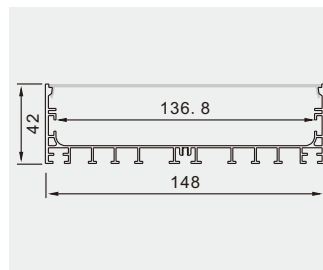

plastic end cap spring clip suspended wire

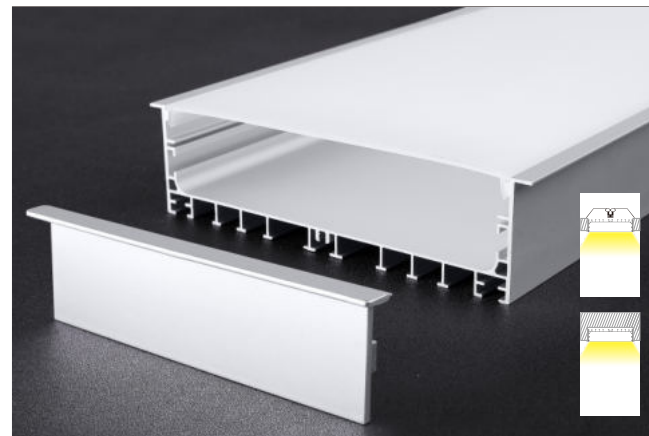

14842A

Description

size: Lx160x42mm
 Material: 6063-T5
 Surface: Silver / black / white Anodized
 PC cover: Milky white/black/acrylic matte
 Apply: LED Strips and PCB 120mm

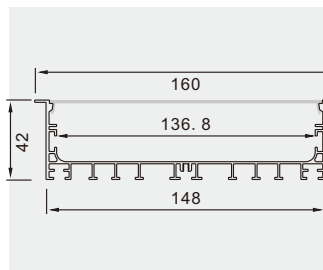

plastic end cap spring clip

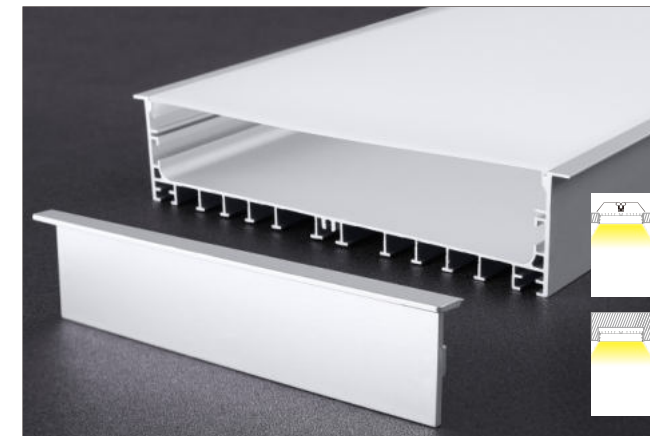

17842A

Description

size: Lx190x42mm
 Material: 6063-T5
 Surface: Silver / black / white Anodized
 PC cover: Milky white/black/acrylic matte
 Apply: LED Strips and PCB 150mm

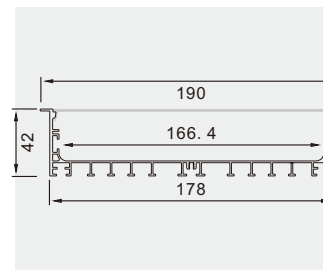

plastic end cap spring clip

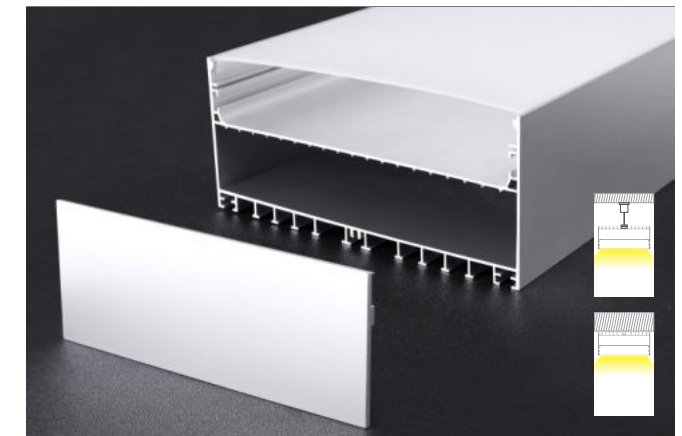

17878M

Description

size: Lx178x78mm
 Material: 6063-T5
 Surface: Silver / black / white Anodized
 PC cover: Milky white/black/acrylic matte
 Apply: LED Strips and PCB 150mm

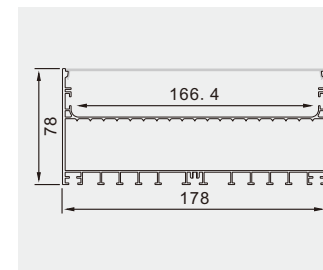

plastic end cap spring clip suspended wire

ALUMINUM PROFILE

LINEAR LIGHT

»» P10-P20



2022
NEW STYLE

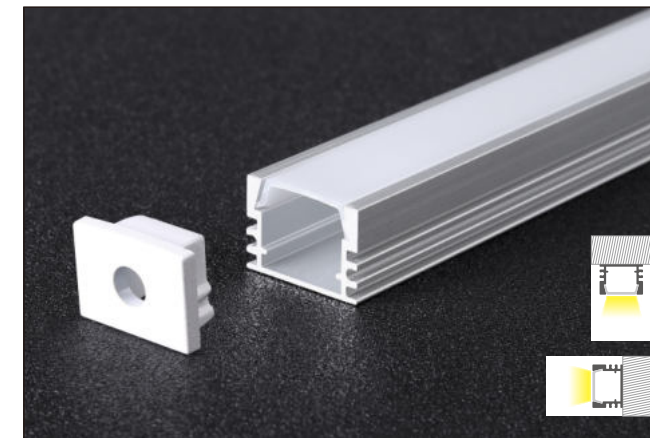

505

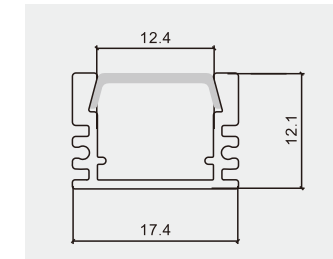

Description

size: Lx17.4x12mm
Material: 6063-T5
Surface: Silver / black / white Anodized
PC cover: Milky white/black/acrylic matte
Apply: LED Strips and PCB 12mm



plastic end cap spring clip



508

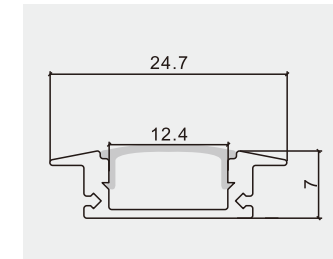

Description

size: Lx24.7x7mm
Material: 6063-T5
Surface: Silver / black / white Anodized
PC cover: Milky white/black/acrylic matte
Apply: LED Strips and PCB 12mm



plastic end cap spring clip



509

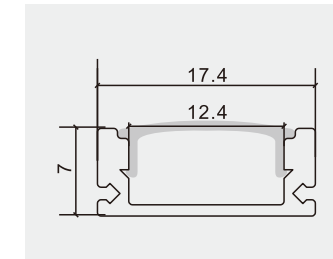

Description

size: Lx17.4x7mm
Material: 6063-T5
Surface: Silver / black / white Anodized
PC cover: Milky white/black/acrylic matte
Apply: LED Strips and PCB 12mm



plastic end cap spring clip



510

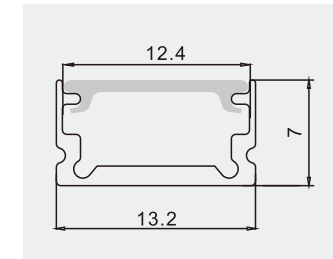

Description

size: Lx13.2x7mm
Material: 6063-T5
Surface: Silver / black / white Anodized
PC cover: Milky white/black/acrylic matte
Apply: LED Strips and PCB 12mm



plastic end cap spring clip

ALUMINUM PROFILE

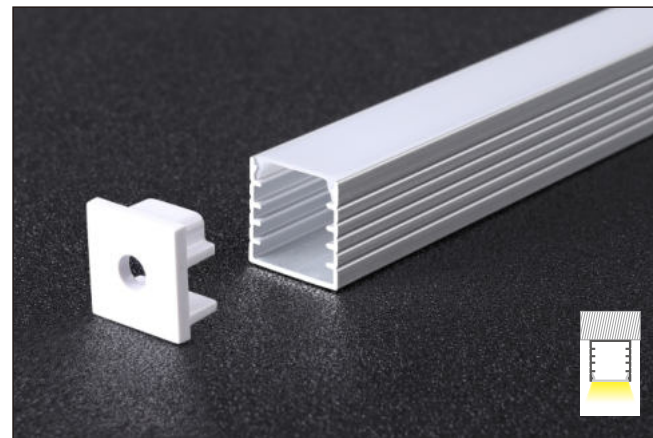

524

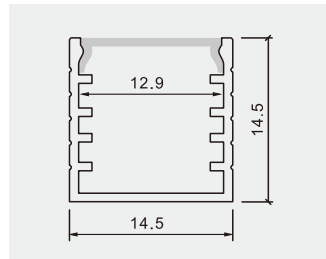

Description

size: Lx14.5x14.5mm
Material: 6063-T5
Surface: Silver / black / white Anodized
PC cover: Milky white/black/acrylic matte
Apply: LED Strips and PCB 12mm



plastic end cap spring clip

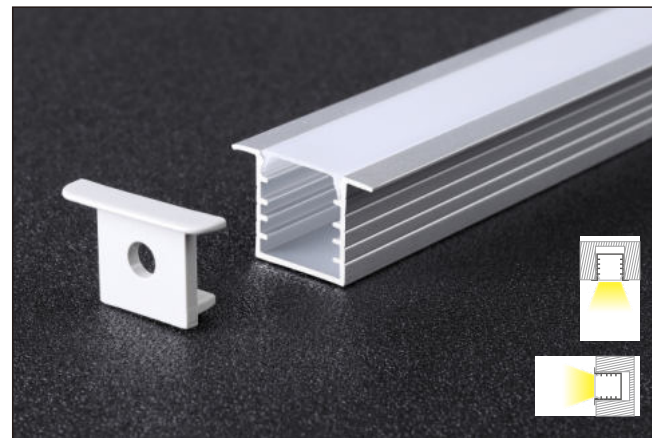

524A

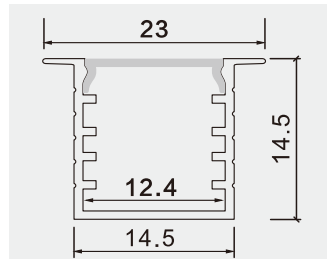

Description

size: Lx23x14.5mm
Material: 6063-T5
Surface: Silver / black / white Anodized
PC cover: Milky white/black/acrylic matte
Apply: LED Strips and PCB 12mm



plastic end cap spring clip



610

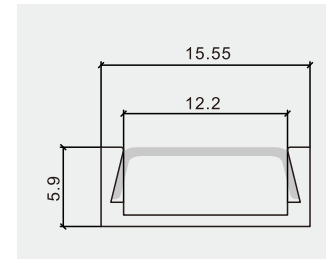

Description

size: Lx15.5x5.9mm
Material: 6063-T5
Surface: Silver / black / white Anodized
PC cover: Milky white/black/acrylic matte
Apply: LED Strips and PCB 12mm



plastic end cap spring clip

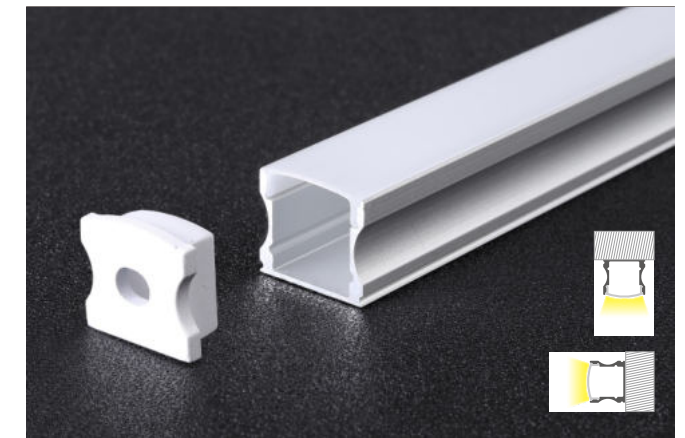

613

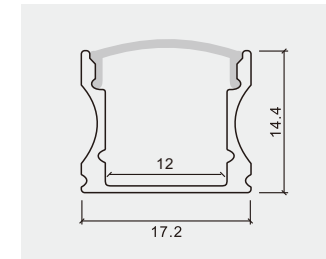

Description

size: Lx17.2x14.4mm
Material: 6063-T5
Surface: Silver / black / white Anodized
PC cover: Milky white/black/acrylic matte
Apply: LED Strips and PCB 12mm



plastic end cap spring clip



601

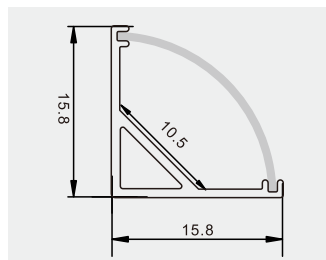

Description

size: Lx15.8x15.8mm
Material: 6063-T5
Surface: Silver / black / white Anodized
PC cover: Milky white/black/acrylic matte
Apply: LED Strips and PCB 10mm



plastic end cap spring clip

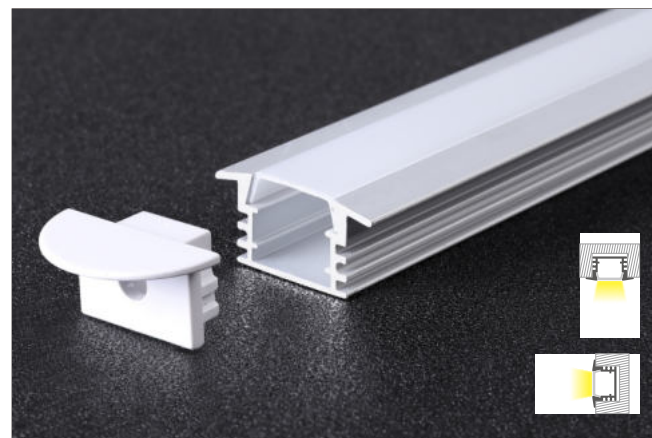

605

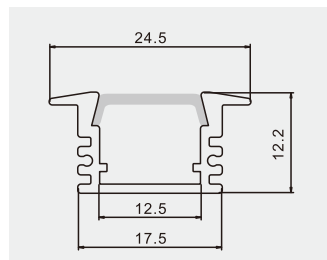

Description

size: Lx24.5x12.2mm
Material: 6063-T5
Surface: Silver / black / white Anodized
PC cover: Milky white/black/acrylic matte
Apply: LED Strips and PCB 12mm



plastic end cap spring clip

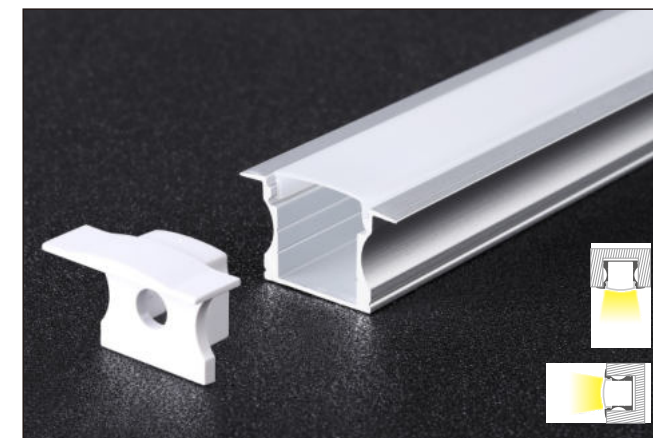

613B

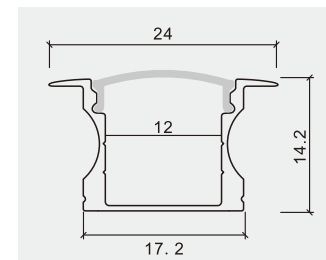

Description

size: Lx24x14.2mm
Material: 6063-T5
Surface: Silver / black / white Anodized
PC cover: Milky white/black/acrylic matte
Apply: LED Strips and PCB 12mm



plastic end cap spring clip

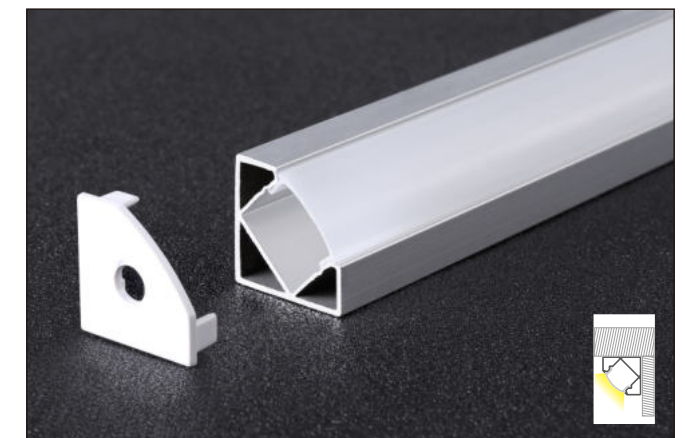

614

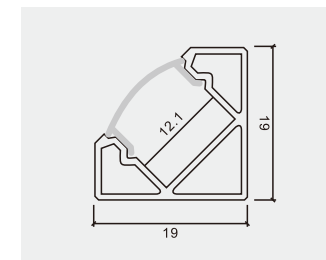

Description

size: Lx19x19mm
Material: 6063-T5
Surface: Silver / black / white Anodized
PC cover: Milky white/black/acrylic matte
Apply: LED Strips and PCB 12mm



plastic end cap spring clip

ALUMINUM PROFILE

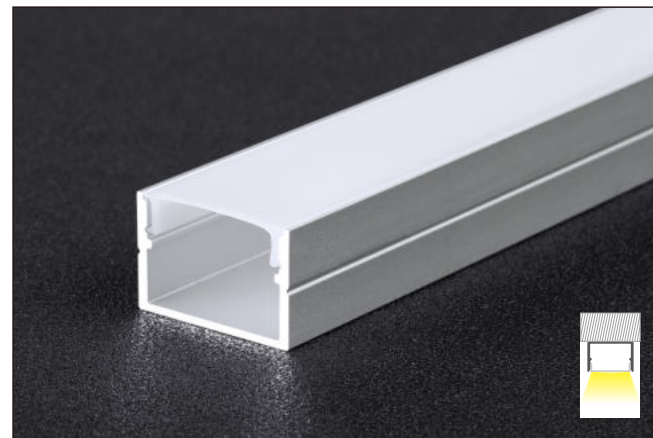

616

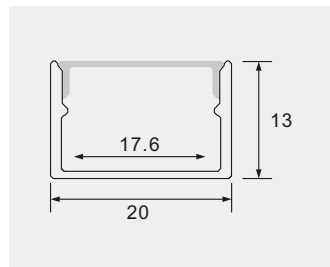

Description

size: Lx20x13mm
Material: 6063-T5
Surface: Silver / black / white Anodized
PC cover: Milky white/black/acrylic matte
Apply: LED Strips and PCB 17.6mm



plastic end cap spring clip

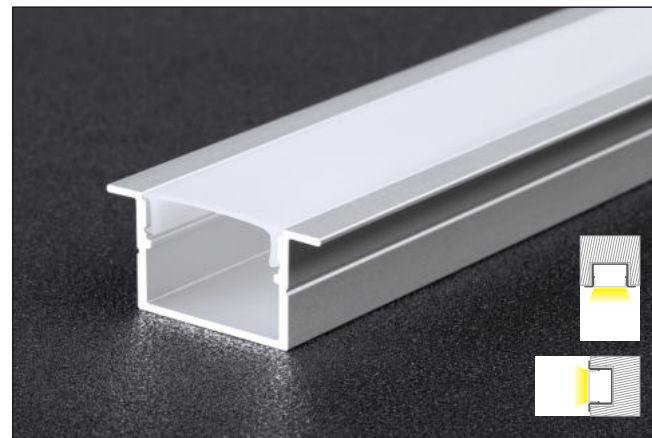

616A

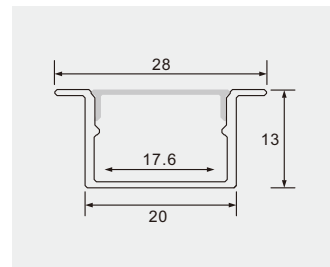

Description

size: Lx28x13mm
Material: 6063-T5
Surface: Silver / black / white Anodized
PC cover: Milky white/black/acrylic matte
Apply: LED Strips and PCB 17.6mm



plastic end cap spring clip



618

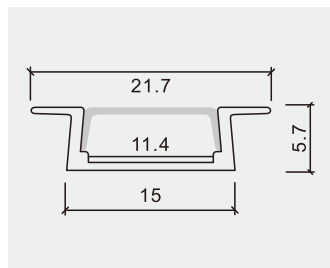

Description

size: Lx21.7x5.7mm
Material: 6063-T5
Surface: Silver / black / white Anodized
PC cover: Milky white/black/acrylic matte
Apply: LED Strips and PCB 11mm



plastic end cap spring clip



623

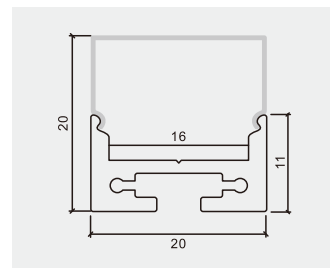

Description

size: Lx20x20mm
Material: 6063-T5
Surface: Silver / black / white Anodized
PC cover: Milky white/black/acrylic matte
Apply: LED Strips and PCB 16mm



plastic end cap spring clip suspended wire

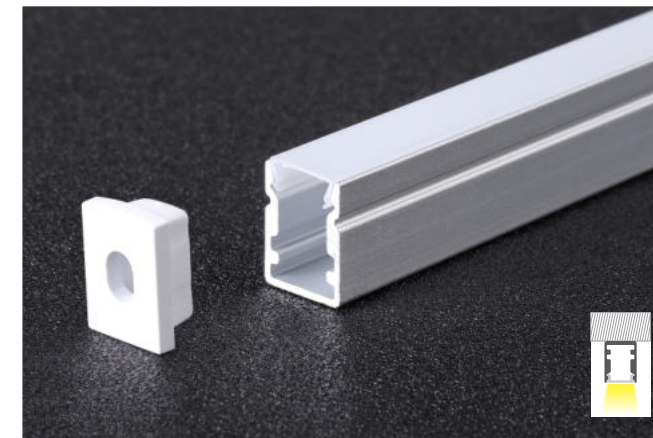

624

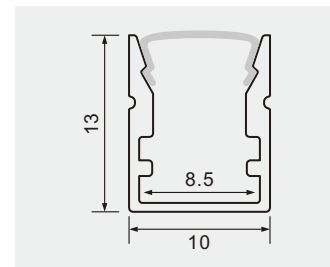

Description

size: Lx10x13mm
Material: 6063-T5
Surface: Silver / black / white Anodized
PC cover: Milky white/black/acrylic matte
Apply: LED Strips and PCB 8mm

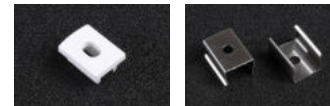

plastic end cap spring clip

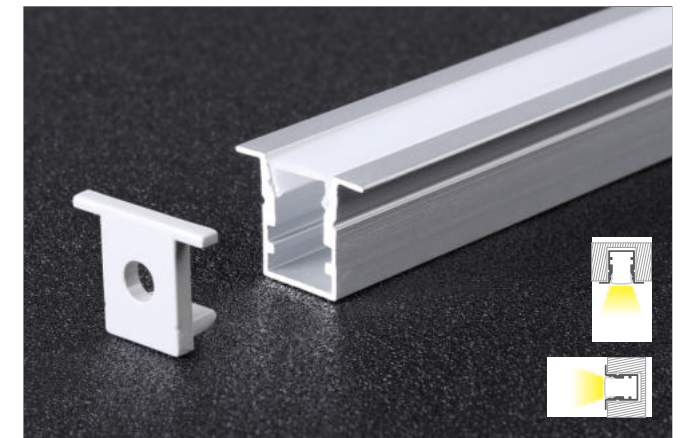

624A

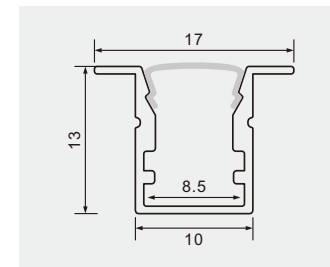

Description

size: Lx17x13mm
Material: 6063-T5
Surface: Silver / black / white Anodized
PC cover: Milky white/black/acrylic matte
Apply: LED Strips and PCB 8mm



plastic end cap spring clip



MA-1

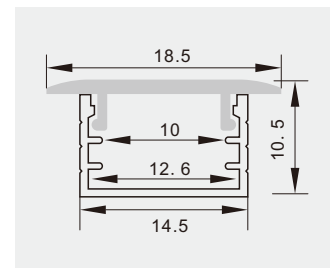

Description

size: Lx18.5x10.5mm
Material: 6063-T5
Surface: Silver / black / white Anodized
PC cover: Milky white/black/acrylic matte
Apply: LED Strips and PCB 12mm



plastic end cap spring clip



1409A

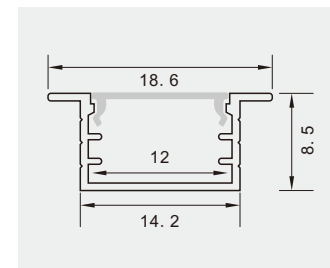

Description

size: Lx18.6x8.5mm
Material: 6063-T5
Surface: Silver / black / white Anodized
PC cover: Milky white/black/acrylic matte
Apply: LED Strips and PCB 12mm

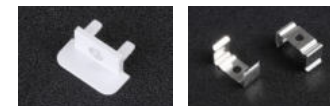

plastic end cap spring clip

ALUMINUM PROFILE



1409M

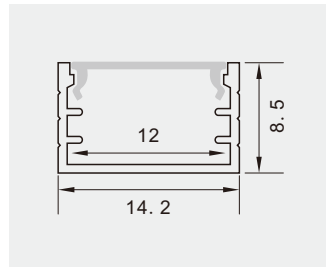

Description

size: Lx14 2x8 5mm
 Material: 6063-T5
 Surface: Silver / black / white Anodized
 PC cover: Milky white/black/acrylic matte
 Apply: LED Strips and PCB 12mm



plastic end cap

spring clip

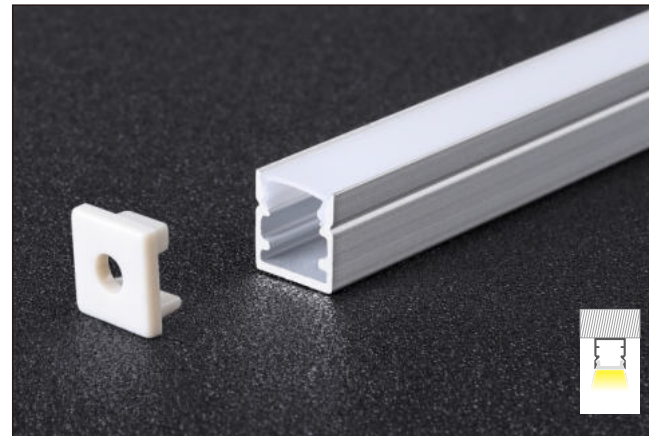

1010M

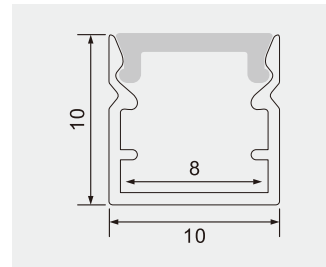

Description

size: Lx10x10mm
 Material: 6063-T5
 Surface: Silver / black / white Anodized
 PC cover: Milky white/black/acrylic matte
 Apply: LED Strips and PCB 8mm

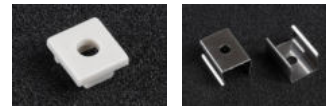

plastic end cap

spring clip

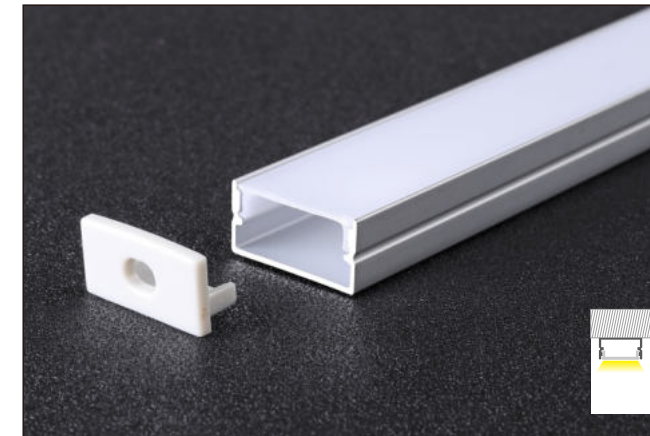

2010M

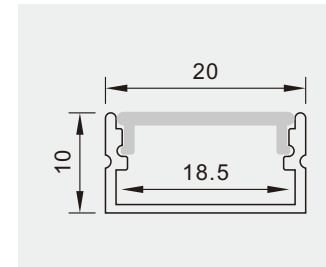

Description

size: Lx20x10mm
 Material: 6063-T5
 Surface: Silver / black / white Anodized
 PC cover: Milky white/black/acrylic matte
 Apply: LED Strips and PCB 18mm



plastic end cap

spring clip



2010A

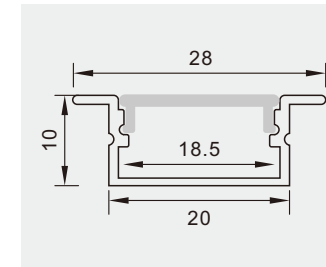

Description

size: Lx28x10mm
 Material: 6063-T5
 Surface: Silver / black / white Anodized
 PC cover: Milky white/black/acrylic matte
 Apply: LED Strips and PCB 18mm



plastic end cap

spring clip

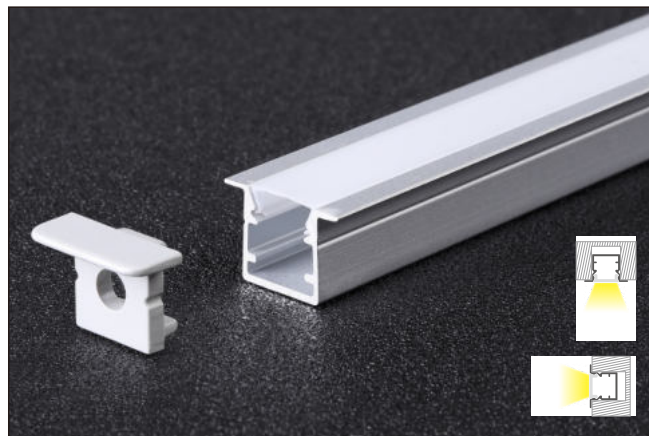

1010A

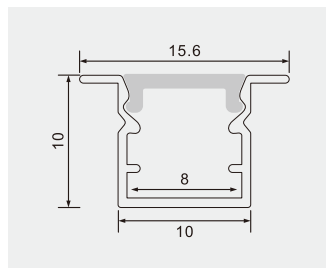

Description

size: Lx15 6x10mm
 Material: 6063-T5
 Surface: Silver / black / white Anodized
 PC cover: Milky white/black/acrylic matte
 Apply: LED Strips and PCB 8mm

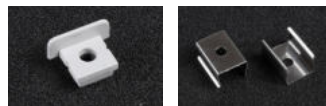

plastic end cap

spring clip



1313

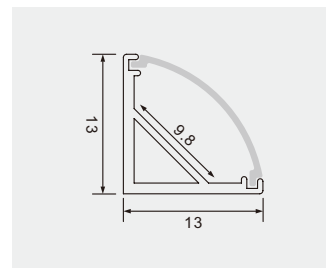

Description

size: Lx13x13mm
 Material: 6063-T5
 Surface: Silver / black / white Anodized
 PC cover: Milky white/black/acrylic matte
 Apply: LED Strips and PCB 9.8mm



plastic end cap

spring clip

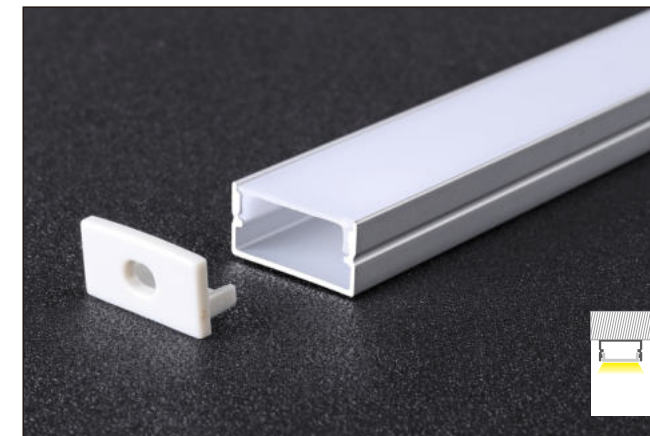

2010M-L

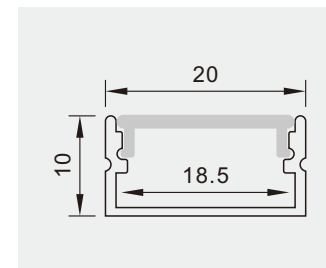

Description

size: Lx20x10mm
 Material: 6063-T5
 Surface: Silver / black / white Anodized
 PC cover: Milky white/black/acrylic matte
 Apply: LED Strips and PCB 18mm



plastic end cap

spring clip

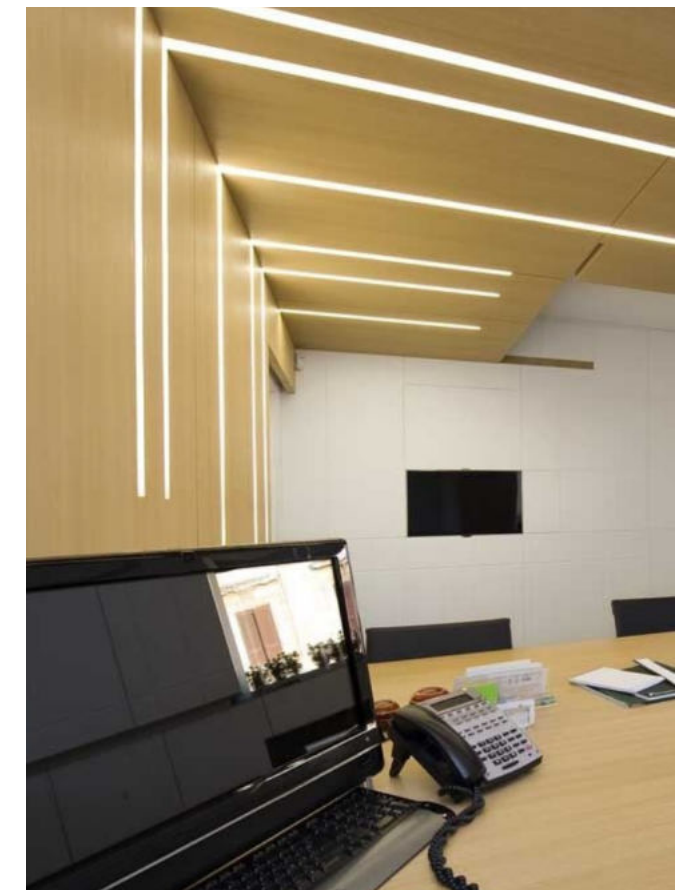

ALUMINUM PROFILE



2010A-L

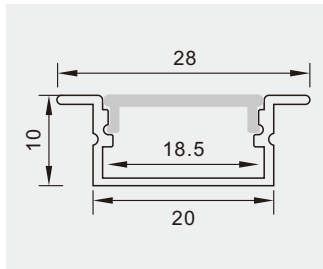

Description

size: Lx28x10mm
Material: 6063-T5
Surface: Silver / black / white Anodized
PC cover: Milky white/black/acrylic matte
Apply: LED Strips and PCB 18mm



plastic end cap

spring clip



2011

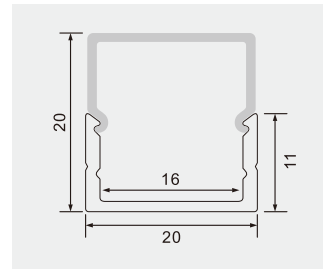

Description

size: Lx20x20mm
Material: 6063-T5
Surface: Silver / black / white Anodized
PC cover: Milky white/black/acrylic matte
Apply: LED Strips and PCB 16mm



plastic end cap

spring clip

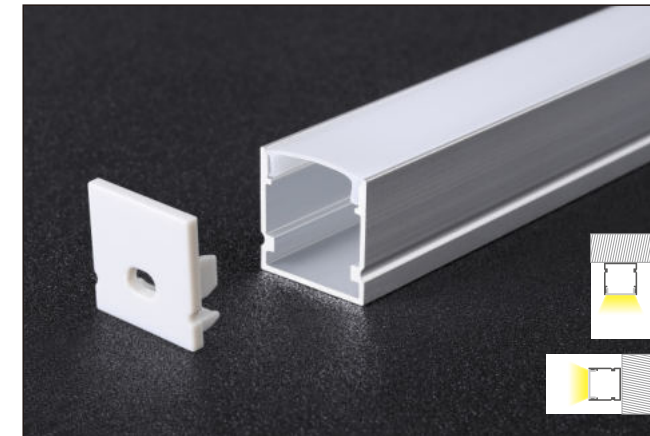

2020M-L

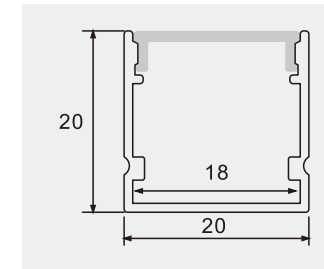

Description

size: Lx20x20mm
Material: 6063-T5
Surface: Silver / black / white Anodized
PC cover: Milky white/black/acrylic matte
Apply: LED Strips and PCB 18mm



plastic end cap

spring clip

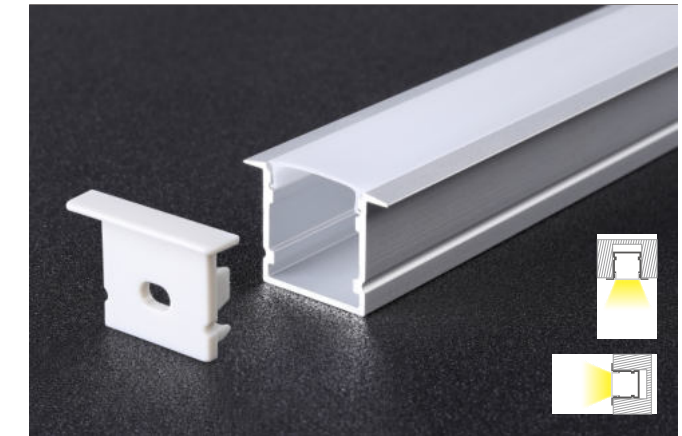

2020A-L

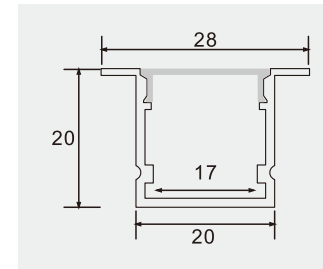

Description

size: Lx28x20mm
Material: 6063-T5
Surface: Silver / black / white Anodized
PC cover: Milky white/black/acrylic matte
Apply: LED Strips and PCB 17mm



plastic end cap

spring clip

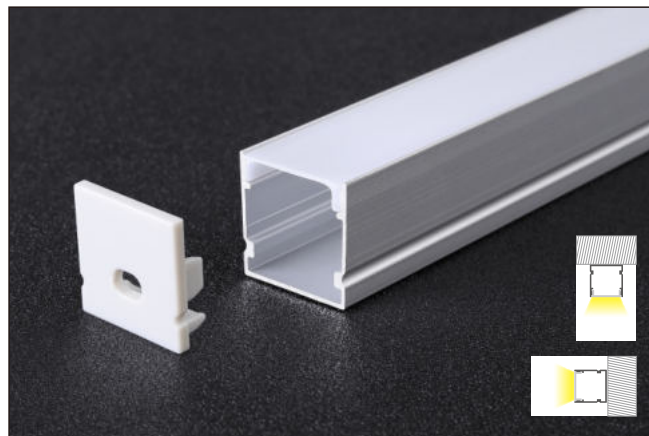

2020M

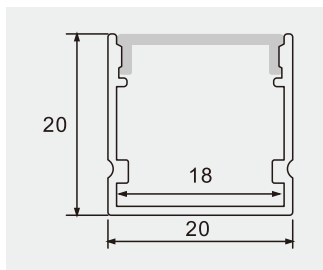

Description

size: Lx20x20mm
Material: 6063-T5
Surface: Silver / black / white Anodized
PC cover: Milky white/black/acrylic matte
Apply: LED Strips and PCB 18mm



塑料堵头
plastic end cap

金属卡子
spring clip



2020A

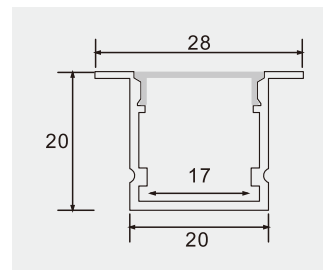

Description

size: Lx28x20mm
Material: 6063-T5
Surface: Silver / black / white Anodized
PC cover: Milky white/black/acrylic matte
Apply: LED Strips and PCB 17mm



塑料堵头
plastic end cap

金属卡子
spring clip



3010M

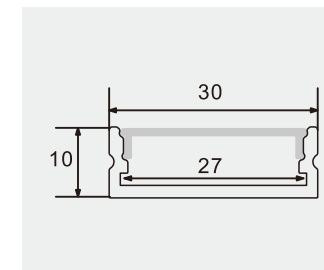

Description

size: Lx30x10mm
Material: 6063-T5
Surface: Silver / black / white Anodized
PC cover: Milky white/black/acrylic matte
Apply: LED Strips and PCB 27mm

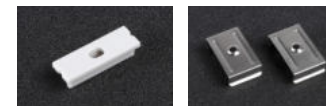

plastic end cap

spring clip

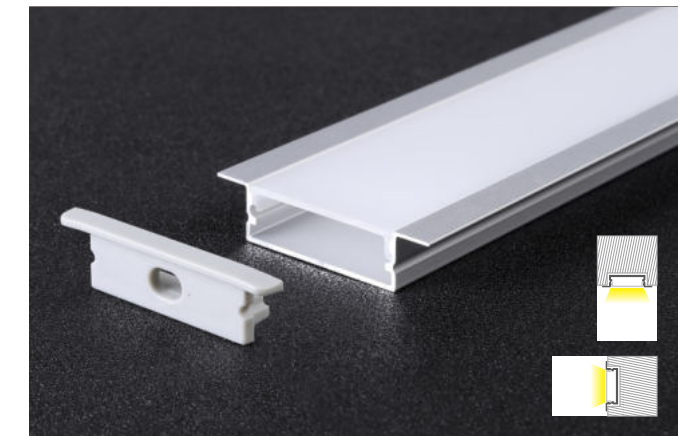

3010A

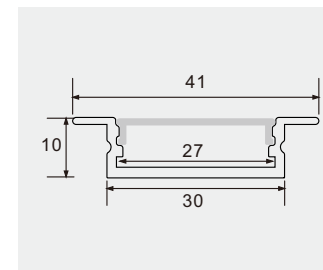

Description

size: Lx41x10mm
Material: 6063-T5
Surface: Silver / black / white Anodized
PC cover: Milky white/black/acrylic matte
Apply: LED Strips and PCB 27mm



plastic end cap

spring clip

ALUMINUM PROFILE



3020M

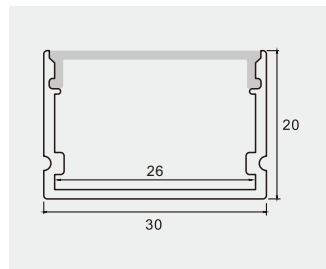

Description

size: Lx30x20mm
Material: 6063-T5
Surface: Silver / black / white Anodized
PC cover: Milky white/black/acrylic matte
Apply: LED Strips and PCB 26mm

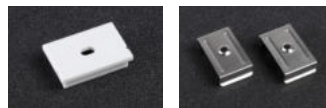

plastic end cap

spring clip



3020A

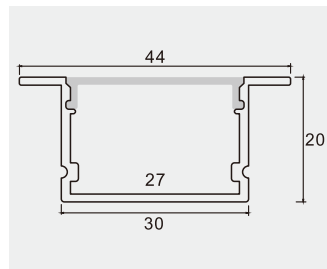

Description

size: Lx44x20mm
Material: 6063-T5
Surface: Silver / black / white Anodized
PC cover: Milky white/black/acrylic matte
Apply: LED Strips and PCB 27mm

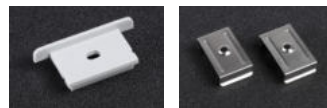

plastic end cap

spring clip

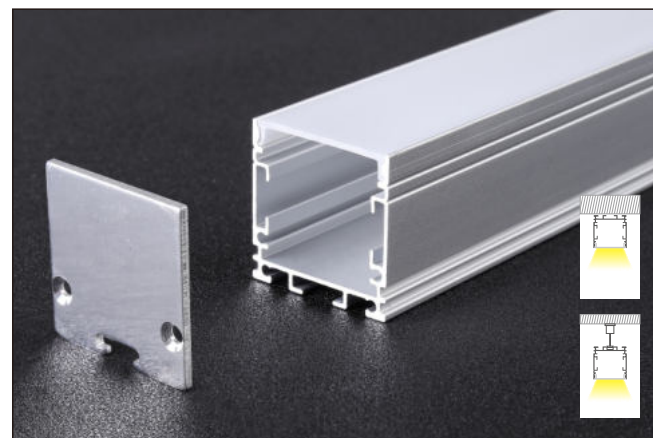

3030M

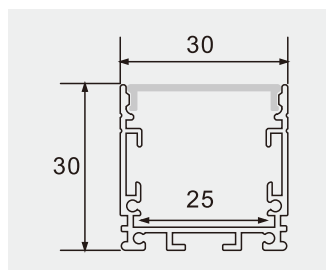

Description

size: Lx30x30mm
Material: 6063-T5
Surface: Silver / black / white Anodized
PC cover: Milky white/black/acrylic matte
Apply: LED Strips and PCB 25mm



金属端头
metal end cap

金属卡子
spring clip

吊钩
suspended wire



3030A

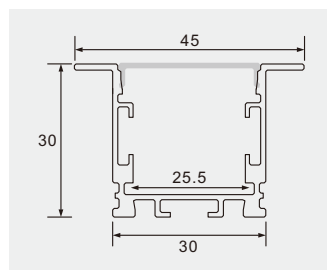

Description

size: Lx45x30mm
Material: 6063-T5
Surface: Silver / black / white Anodized
PC cover: Milky white/black/acrylic matte
Apply: LED Strips and PCB 25mm

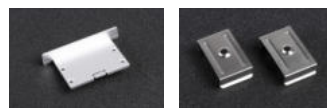

plastic end cap

spring clip

Linear light -office

铝型材套件

»»» P21-P36



2022
NEW STYLE

ALUMINUM PROFILE

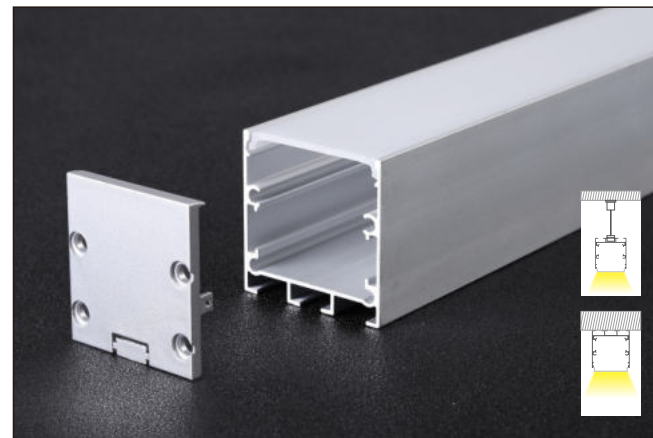

3535M

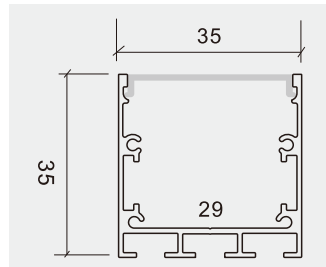

Description

size: Lx35x35mm
Material: 6063-T5
Surface: Silver / black / white Anodized
PC cover: Milky white/black/acrylic matte
Apply: LED Strips and PCB 29mm



plastic end cap spring clip suspended wire

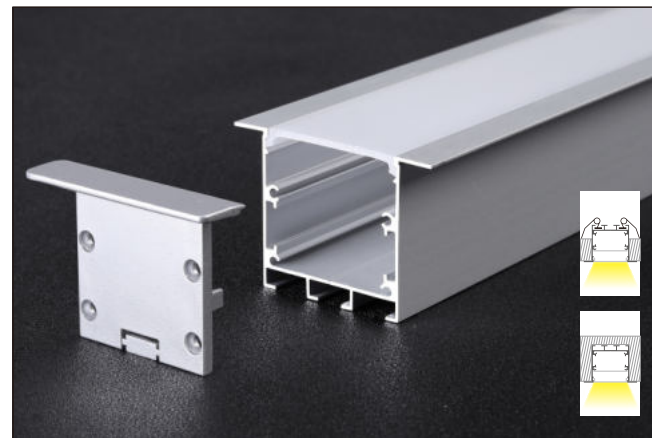

3535A

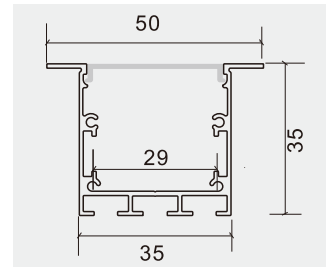

Description

size: Lx50x35mm
Material: 6063-T5
Surface: Silver / black / white Anodized
PC cover: Milky white/black/acrylic matte
Apply: LED Strips and PCB 29mm



plastic end cap spring clip



4035M

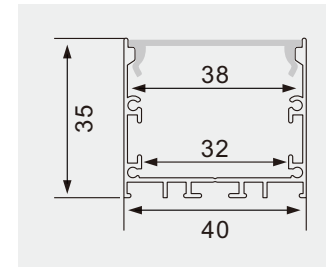

Description

size: Lx40x35mm
Material: 6063-T5
Surface: Silver / black / white Anodized
PC cover: Milky white/black/acrylic matte
Apply: LED Strips and PCB 32mm



plastic end cap spring clip suspended wire



4035A

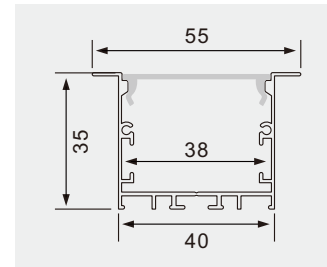

Description

size: Lx55x35mm
Material: 6063-T5
Surface: Silver / black / white Anodized
PC cover: Milky white/black/acrylic matte
Apply: LED Strips and PCB 38mm



plastic end cap spring clip



4020M

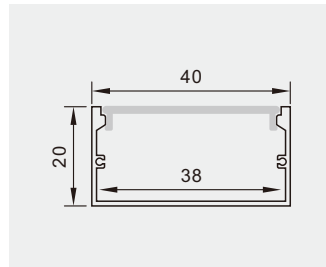

Description

size: Lx40x20mm
Material: 6063-T5
Surface: Silver / black / white Anodized
PC cover: Milky white/black/acrylic matte
Apply: LED Strips and PCB 38mm



plastic end cap

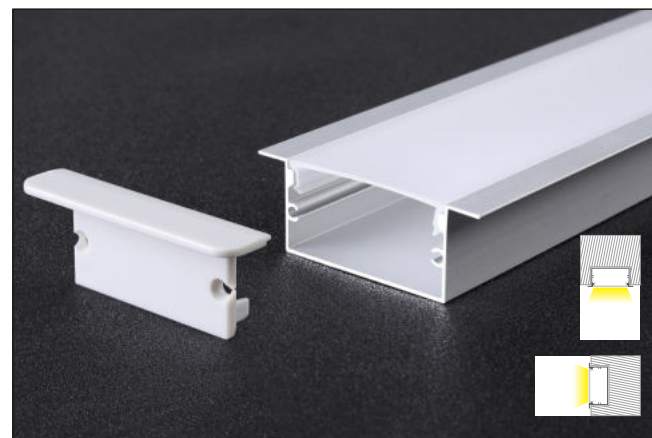

4020A

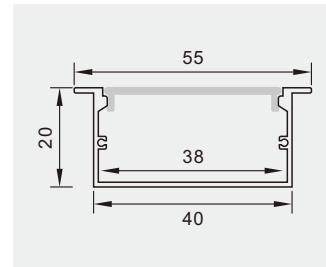

Description

size: Lx55x20mm
Material: 6063-T5
Surface: Silver / black / white Anodized
PC cover: Milky white/black/acrylic matte
Apply: LED Strips and PCB 38mm



plastic end cap

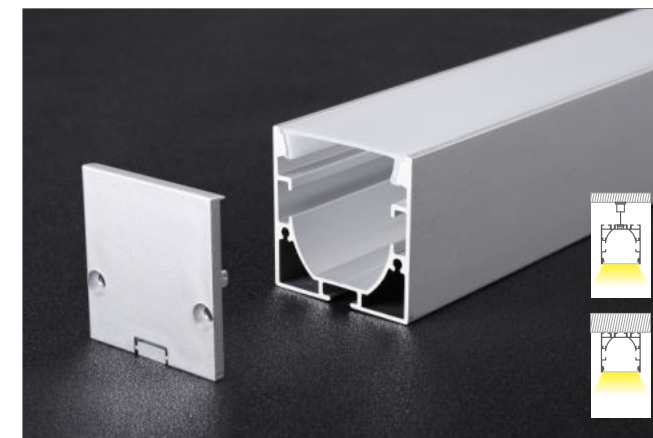

4040M

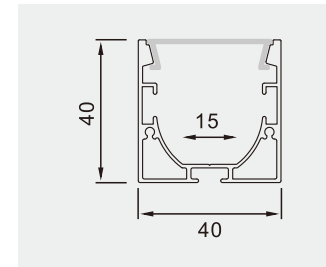

Description

size: Lx40x40mm
Material: 6063-T5
Surface: Silver / black / white Anodized
PC cover: Milky white/black/acrylic matte
Apply: LED Strips and PCB 15mm



plastic end cap spring clip suspended wire

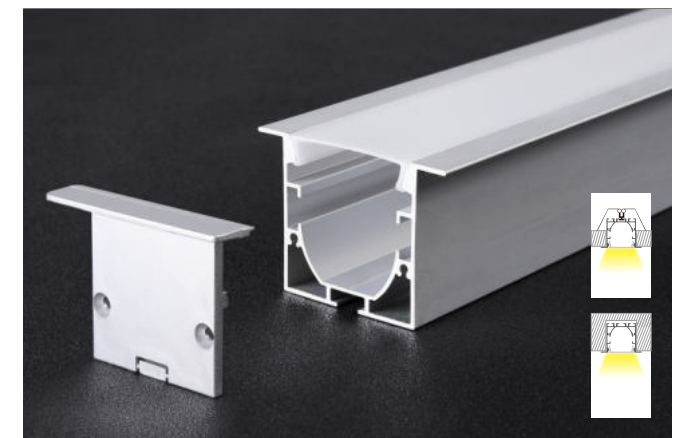

4040A

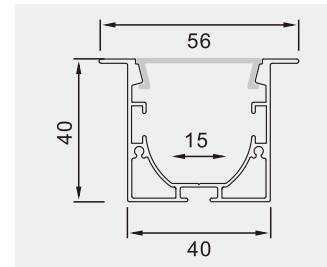

Description

size: Lx56x40mm
Material: 6063-T5
Surface: Silver / black / white Anodized
PC cover: Milky white/black/acrylic matte
Apply: LED Strips and PCB 15mm



plastic end cap spring clip

ALUMINUM PROFILE

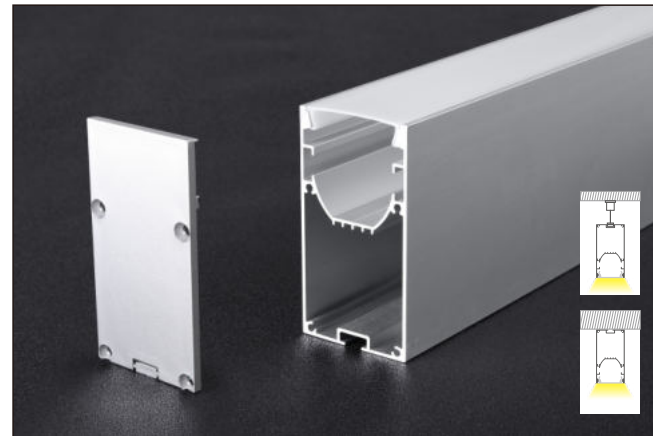

4075M

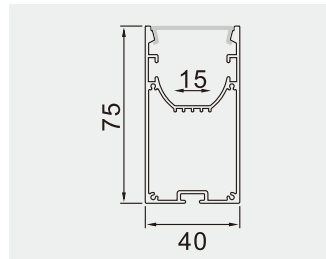

Description

size: Lx40x75mm
 Material: 6063-T5
 Surface: Silver / black / white Anodized
 PC cover: Milky white/black/acrylic matte
 Apply: LED Strips and PCB 15mm



plastic end cap spring clip suspended wire



706

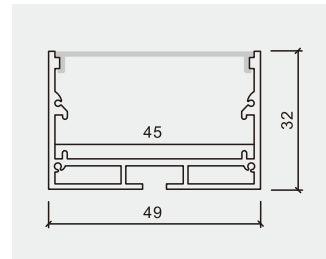

Description

size: Lx49x32mm
 Material: 6063-T5
 Surface: Silver / black / white Anodized
 PC cover: Milky white/black/acrylic matte
 Apply: LED Strips and PCB 45mm



metal end cap spring clip suspended wire

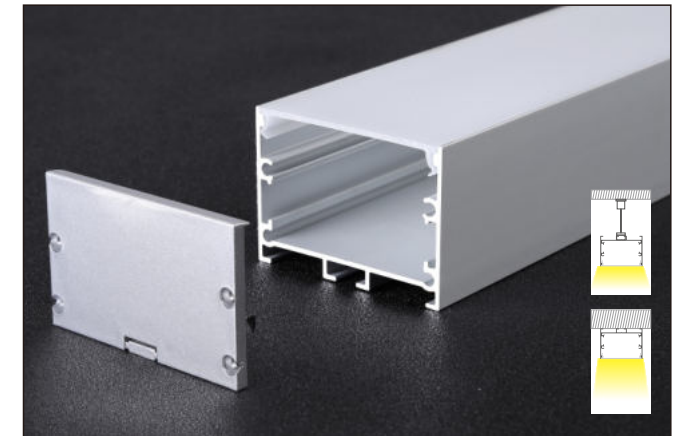
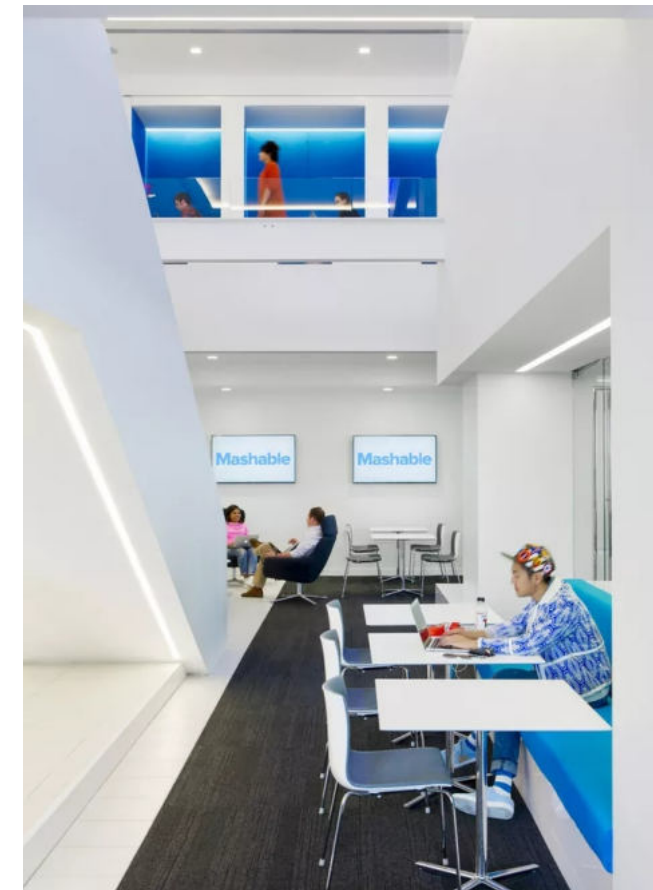

5035M

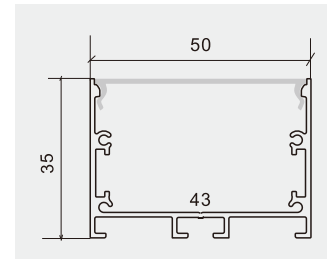

Description

size: Lx50x35mm
 Material: 6063-T5
 Surface: Silver / black / white Anodized
 PC cover: Milky white/black/acrylic matte
 Apply: LED Strips and PCB 43mm



plastic end cap spring clip suspended wire

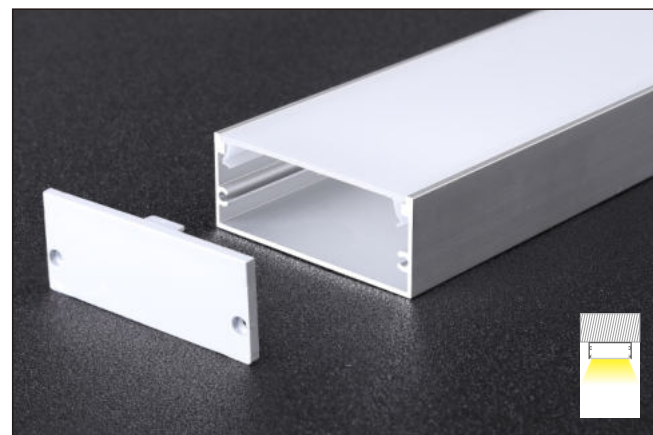

5020M

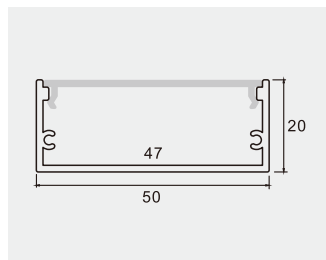

Description

size: Lx50x20mm
 Material: 6063-T5
 Surface: Silver / black / white Anodized
 PC cover: Milky white/black/acrylic matte
 Apply: LED Strips and PCB 47mm



plastic end cap

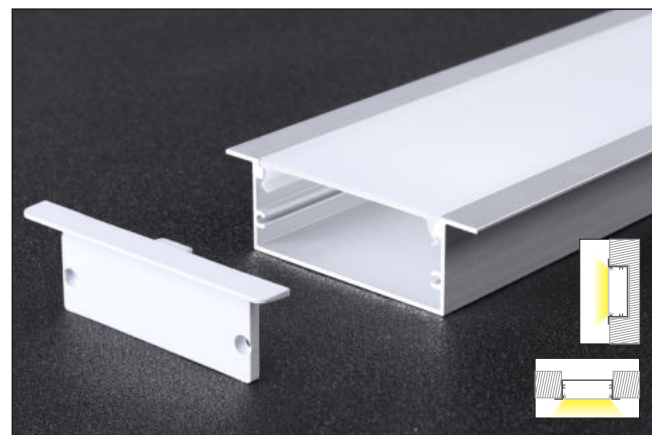

5020A

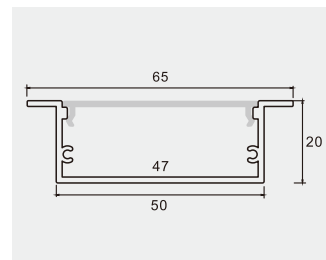

Description

size: Lx65x20mm
 Material: 6063-T5
 Surface: Silver / black / white Anodized
 PC cover: Milky white/black/acrylic matte
 Apply: LED Strips and PCB 47mm



plastic end cap

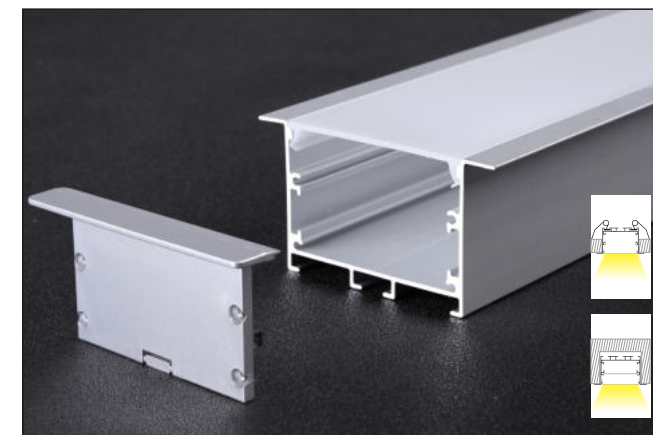

5035A

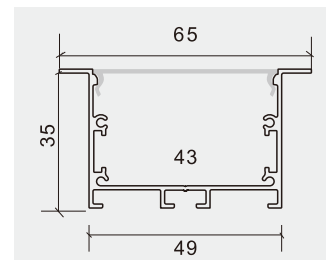

Description

size: Lx65x35mm
 Material: 6063-T5
 Surface: Silver / black / white Anodized
 PC cover: Milky white/black/acrylic matte
 Apply: LED Strips and PCB 43mm



塑料堵头 plastic end cap 金属卡子 spring clip



5035M-L

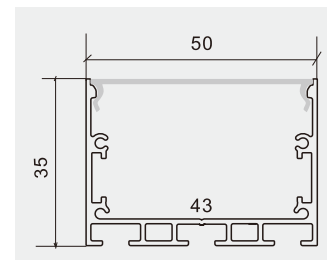

Description

size: Lx50x35mm
 Material: 6063-T5
 Surface: Silver / black / white Anodized
 PC cover: Milky white/black/acrylic matte
 Apply: LED Strips and PCB 43mm



plastic end cap spring clip suspended wire

ALUMINUM PROFILE



5035A-L

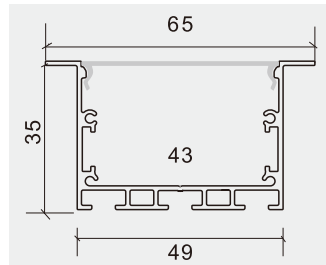

Description

size: Lx65x35mm
Material: 6063-T5
Surface: Silver / black / white Anodized
PC cover: Milky white/black/acrylic matte
Apply: LED Strips and PCB 43mm



plastic end cap spring clip

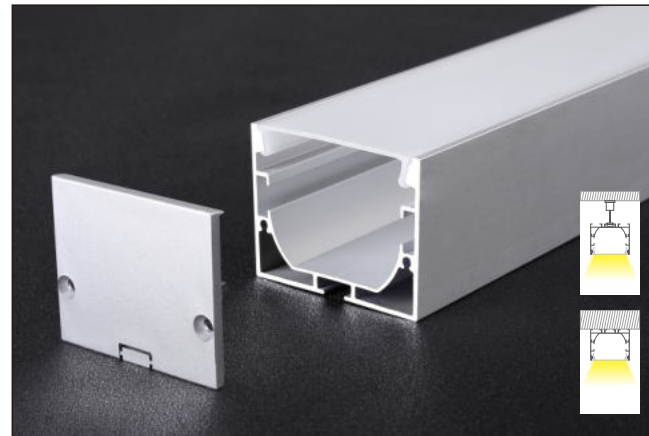

5040M

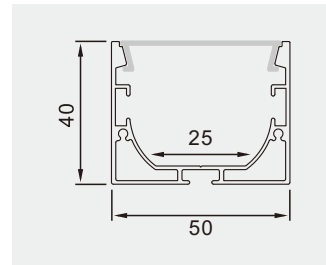

Description

size: Lx50x40mm
Material: 6063-T5
Surface: Silver / black / white Anodized
PC cover: Milky white/black/acrylic matte
Apply: LED Strips and PCB 25mm



plastic end cap spring clip suspended wire

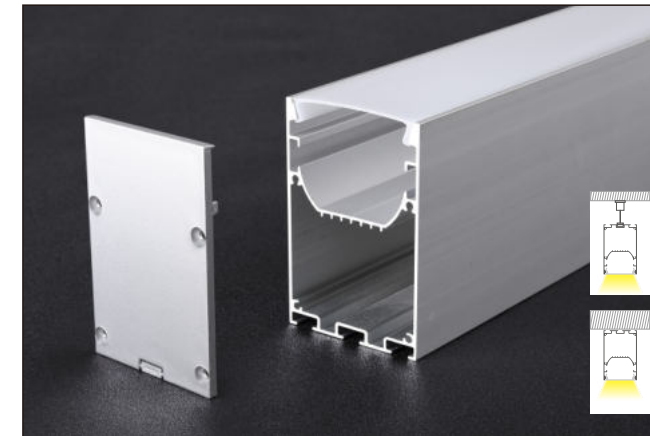

5075M

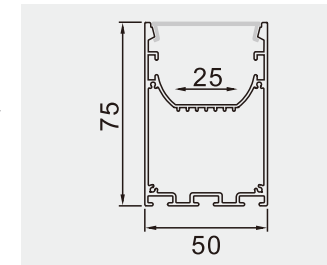

Description

size: Lx50x75mm
Material: 6063-T5
Surface: Silver / black / white Anodized
PC cover: Milky white/black/acrylic matte
Apply: LED Strips and PCB 25mm



plastic end cap spring clip suspended wire

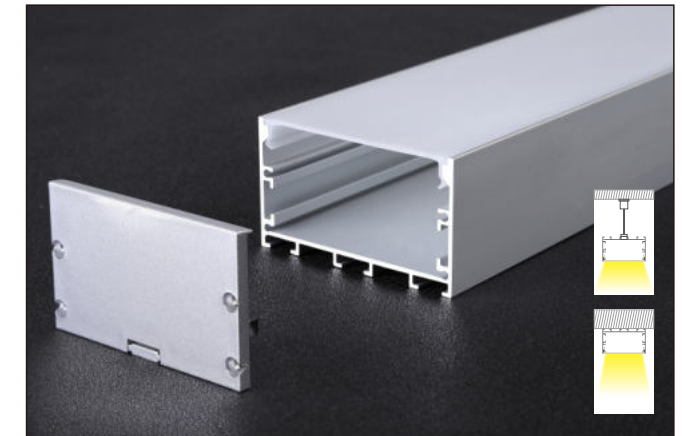

6035M

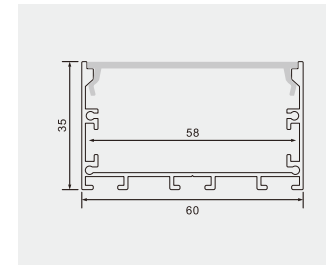

Description

size: Lx60x35mm
Material: 6063-T5
Surface: Silver / black / white Anodized
PC cover: Milky white/black/acrylic matte
Apply: LED Strips and PCB 58mm



plastic end cap spring clip suspended wire

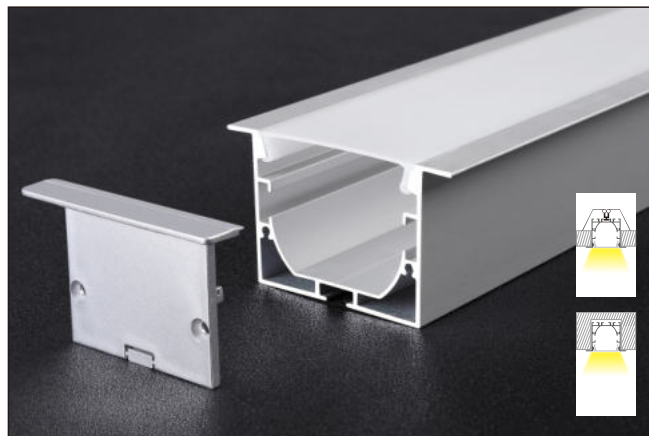

5040A

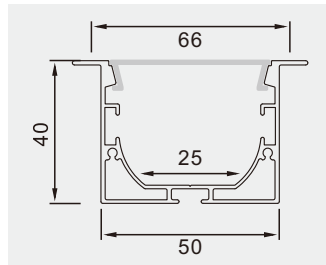

Description

size: Lx66x40mm
Material: 6063-T5
Surface: Silver / black / white Anodized
PC cover: Milky white/black/acrylic matte
Apply: LED Strips and PCB 25mm

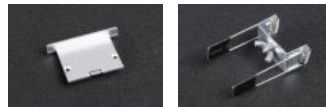

plastic end cap spring clip

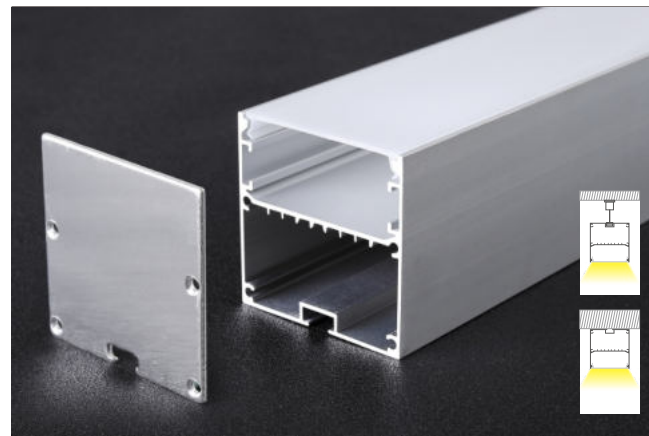

5050M

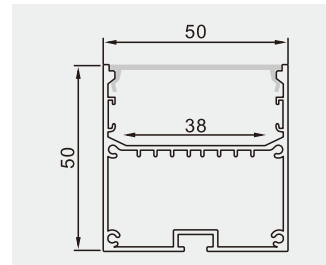

Description

size: Lx50x50mm
Material: 6063-T5
Surface: Silver / black / white Anodized
PC cover: Milky white/black/acrylic matte
Apply: LED Strips and PCB 38mm



metal end cap spring clip suspended wire

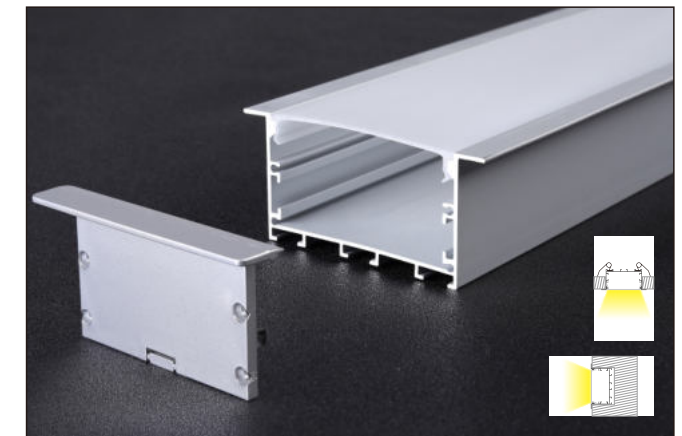

6035A

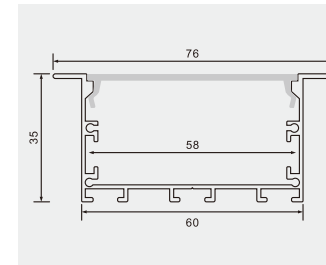

Description

size: Lx76x35mm
Material: 6063-T5
Surface: Silver / black / white Anodized
PC cover: Milky white/black/acrylic matte
Apply: LED Strips and PCB 58mm



plastic end cap spring clip

ALUMINUM PROFILE

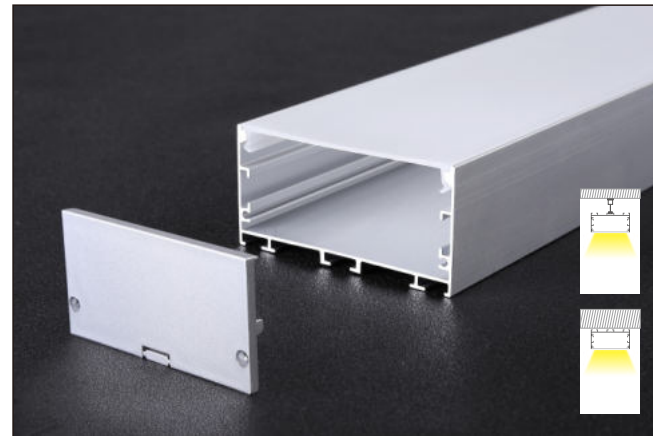

7035M

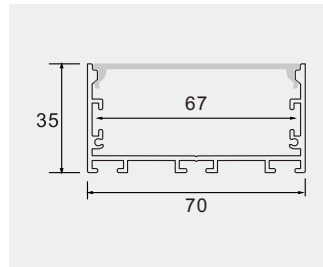

Desciption

size: Lx70x35mm
Material: 6063-T5
Surface: Silver / black / white Anodized
PC cover: Milky white/black/acrylic matte
Apply: LED Strips and PCB 67mm



plastic end cap spring clip suspended wire



7035A

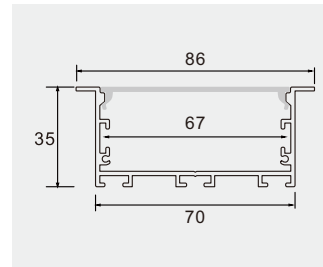

Desciption

size: Lx86x35mm
Material: 6063-T5
Surface: Silver / black / white Anodized
PC cover: Milky white/black/acrylic matte
Apply: LED Strips and PCB 67mm



plastic end cap spring clip

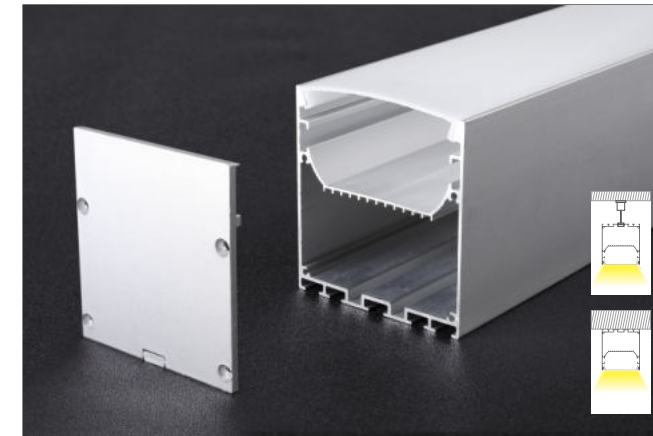

7075M

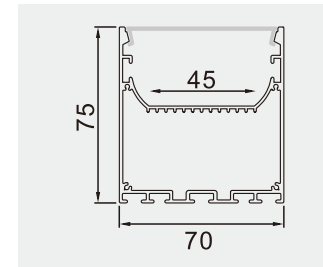

Desciption

size: Lx70x75mm
Material: 6063-T5
Surface: Silver / black / white Anodized
PC cover: Milky white/black/acrylic matte
Apply: LED Strips and PCB 45mm



plastic end cap spring clip suspended wire



7635M

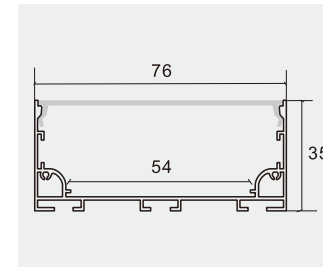

Desciption

size: Lx76x35mm
Material: 6063-T5
Surface: Silver / black / white Anodized
PC cover: Milky white/black/acrylic matte
Apply: LED Strips and PCB 54mm



plastic end cap spring clip suspended wire

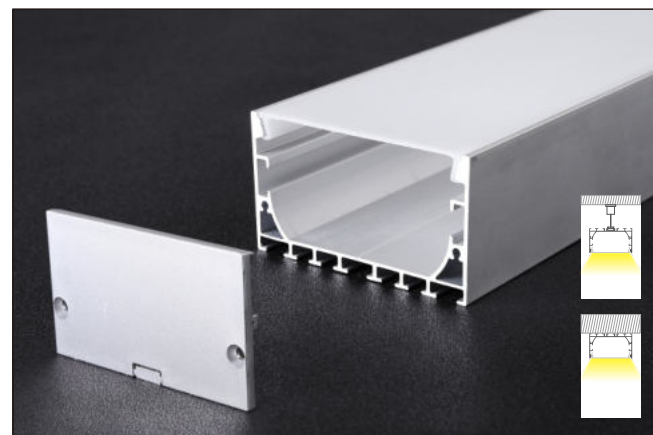

7040M

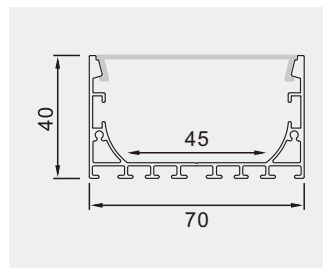

Desciption

size: Lx70x40mm
Material: 6063-T5
Surface: Silver / black / white Anodized
PC cover: Milky white/black/acrylic matte
Apply: LED Strips and PCB 45mm



plastic end cap spring clip suspended wire



7040A

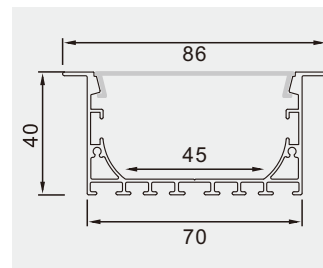

Desciption

size: Lx86x40mm
Material: 6063-T5
Surface: Silver / black / white Anodized
PC cover: Milky white/black/acrylic matte
Apply: LED Strips and PCB 45mm



plastic end cap spring clip



7635A

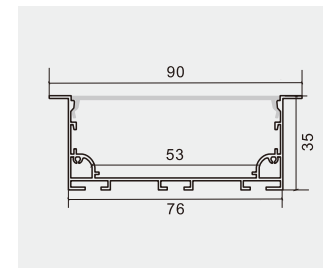

Desciption

size: Lx90x35mm
Material: 6063-T5
Surface: Silver / black / white Anodized
PC cover: Milky white/black/acrylic matte
Apply: LED Strips and PCB 53mm



plastic end cap spring clip

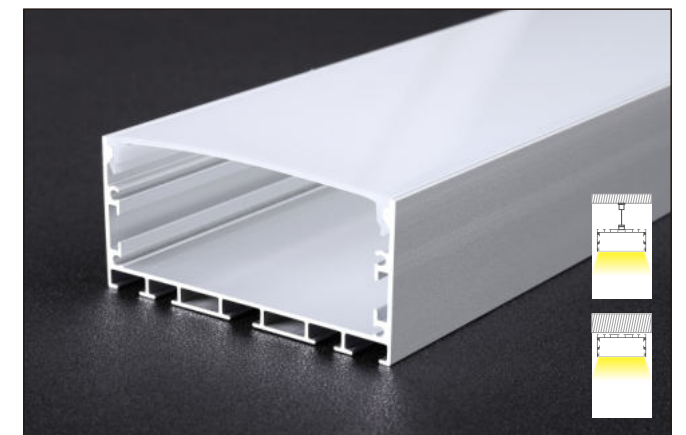

7635M-L

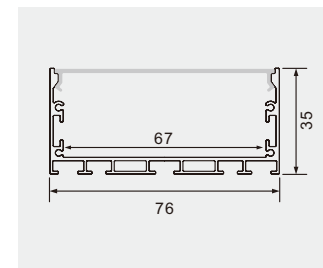

Desciption

size: Lx76x35mm
Material: 6063-T5
Surface: Silver / black / white Anodized
PC cover: Milky white/black/acrylic matte
Apply: LED Strips and PCB 67mm



plastic end cap spring clip suspended wire

ALUMINUM PROFILE

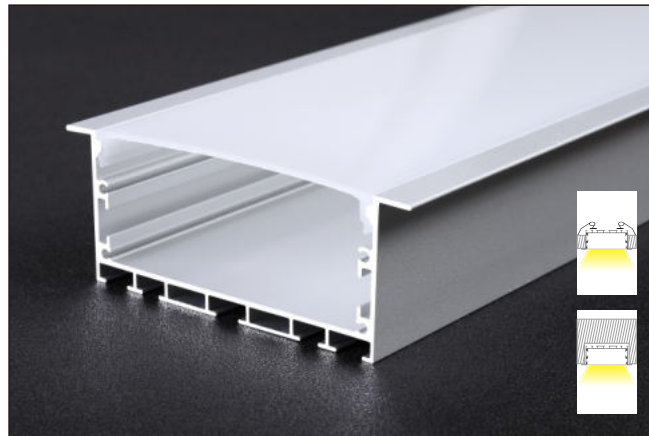

7635A-L

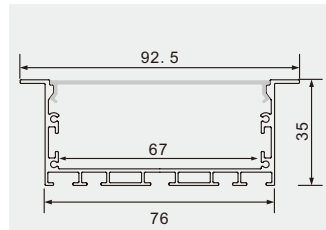

Description

size: Lx92.5x35mm
 Material: 6063-T5
 Surface: Silver / black / white Anodized
 PC cover: Milky white/black/acrylic matte
 Apply: LED Strips and PCB 67mm



plastic end cap spring clip

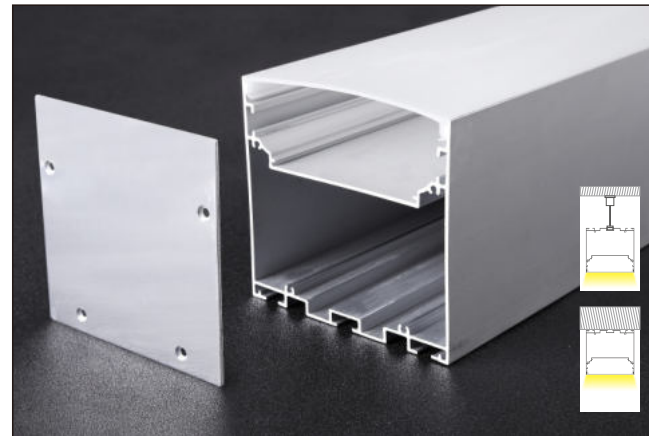

7676M

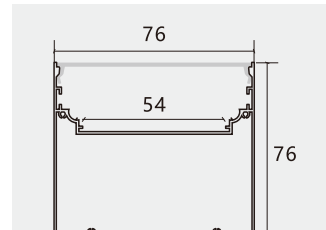

Description

size: Lx76x76mm
 Material: 6063-T5
 Surface: Silver / black / white Anodized
 PC cover: Milky white/black/acrylic matte
 Apply: LED Strips and PCB 54mm



metal end cap spring clip suspended wire

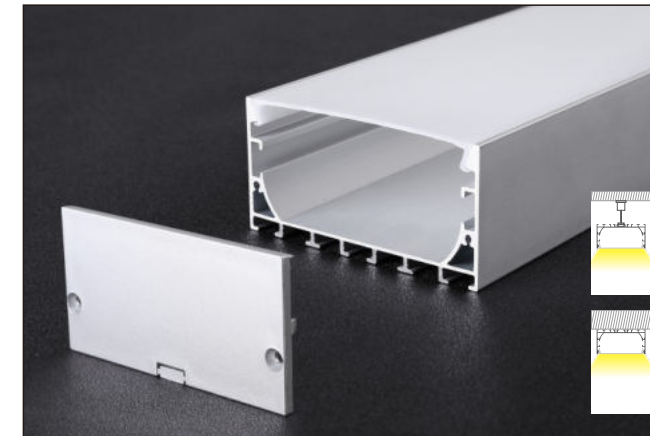

8040M

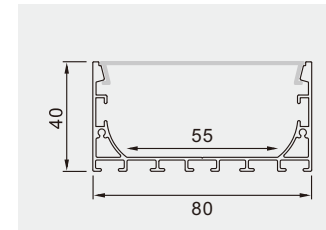

Description

size: Lx80x40mm
 Material: 6063-T5
 Surface: Silver / black / white Anodized
 PC cover: Milky white/black/acrylic matte
 Apply: LED Strips and PCB 55mm



plastic end cap spring clip suspended wire



8040A

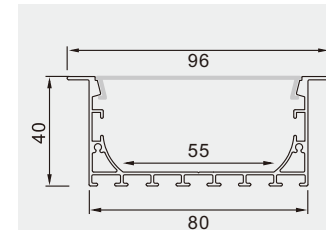

Description

size: Lx96x40mm
 Material: 6063-T5
 Surface: Silver / black / white Anodized
 PC cover: Milky white/black/acrylic matte
 Apply: LED Strips and PCB 55mm



plastic end cap spring clip



8035M

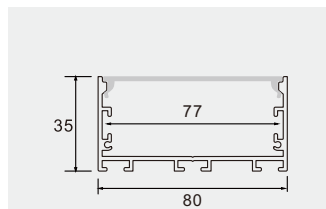

Description

size: Lx80x35mm
 Material: 6063-T5
 Surface: Silver / black / white Anodized
 PC cover: Milky white/black/acrylic matte
 Apply: LED Strips and PCB 77mm



plastic end cap spring clip suspended wire



8035A

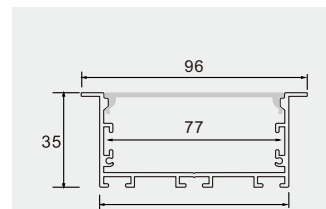

Description

size: Lx96x35mm
 Material: 6063-T5
 Surface: Silver / black / white Anodized
 PC cover: Milky white/black/acrylic matte
 Apply: LED Strips and PCB 77mm



plastic end cap spring clip

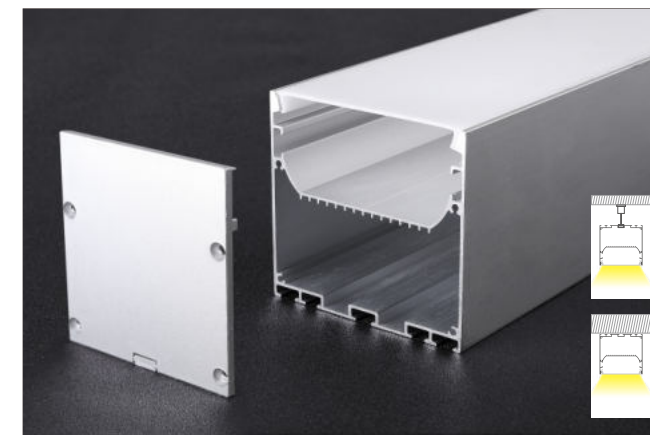

8075M

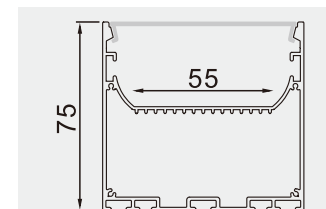

Description

size: Lx80x75mm
 Material: 6063-T5
 Surface: Silver / black / white Anodized
 PC cover: Milky white/black/acrylic matte
 Apply: LED Strips and PCB 55mm



plastic end cap spring clip suspended wire

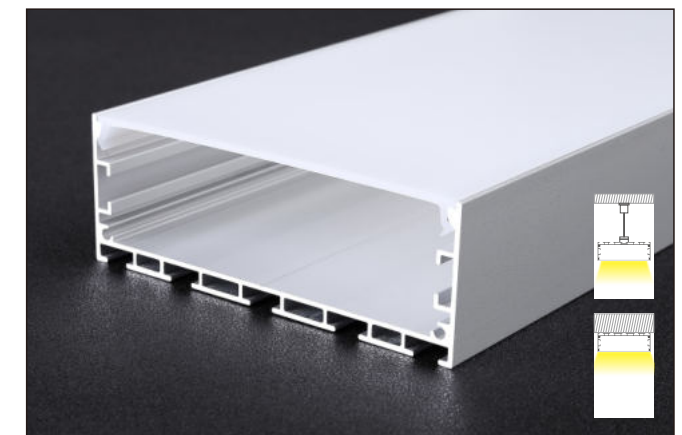

10035M-L

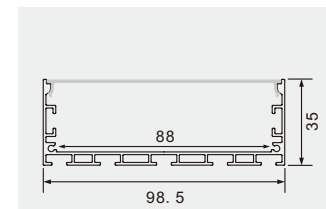

Description

size: Lx98.5x35mm
 Material: 6063-T5
 Surface: Silver / black / white Anodized
 PC cover: Milky white/black/acrylic matte
 Apply: LED Strips and PCB 88mm



塑料堵头 金属卡子 铁丝
 plastic end cap spring clip suspended wire

ALUMINUM PROFILE

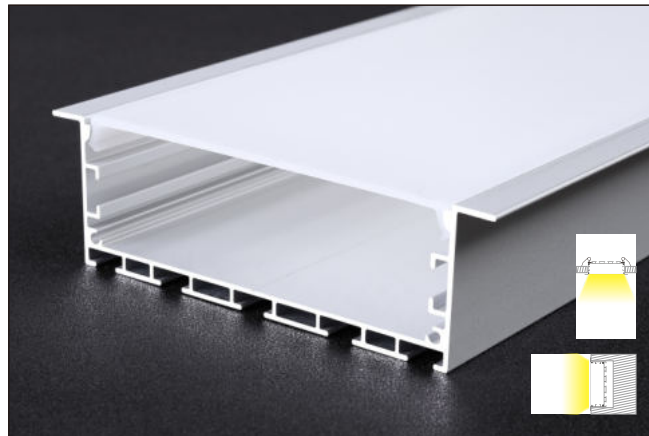

10035A-L

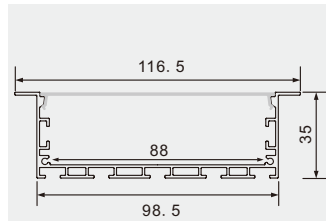

Description

size: Lx116.5x35mm
 Material: 6063-T5
 Surface: Silver / black / white Anodized
 PC cover: Milky white/black/acrylic matte
 Apply: LED Strips and PCB 88mm



plastic end cap spring clip

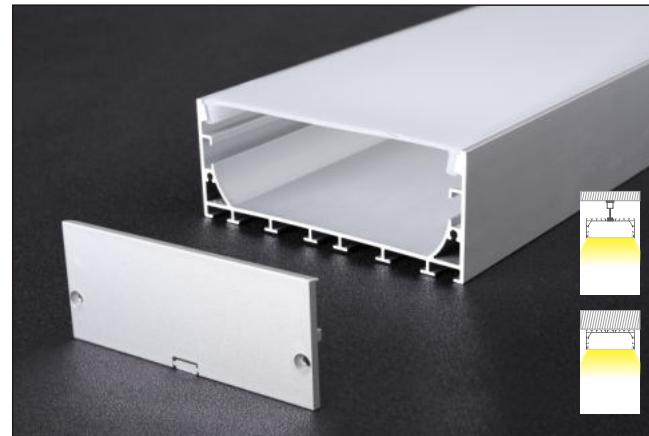

10040M

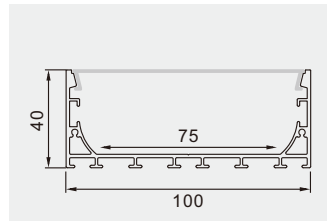

Description

size: Lx100x40mm
 Material: 6063-T5
 Surface: Silver / black / white Anodized
 PC cover: Milky white/black/acrylic matte
 Apply: LED Strips and PCB 75mm



plastic end cap spring clip suspended wire



10235M

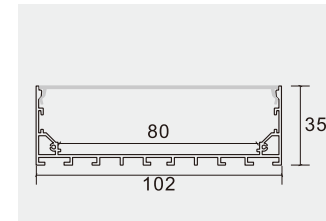

Description

size: Lx102x35mm
 Material: 6063-T5
 Surface: Silver / black / white Anodized
 PC cover: Milky white/black/acrylic matte
 Apply: LED Strips and PCB 80mm



plastic end cap spring clip suspended wire



10040A

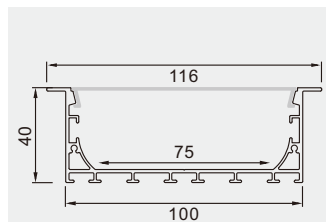

Description

size: Lx116x40mm
 Material: 6063-T5
 Surface: Silver / black / white Anodized
 PC cover: Milky white/black/acrylic matte
 Apply: LED Strips and PCB 75mm



plastic end cap spring clip

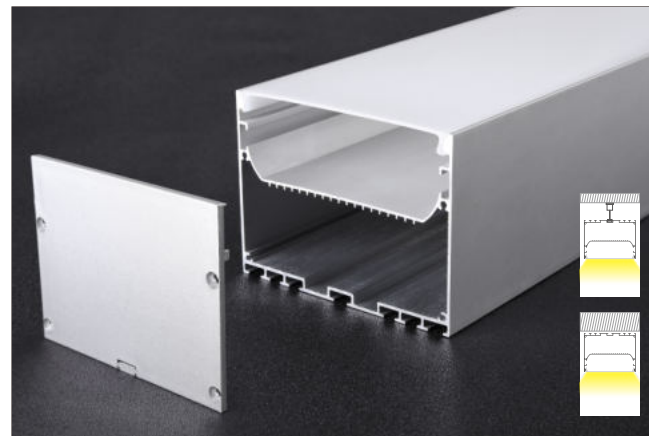

10075M

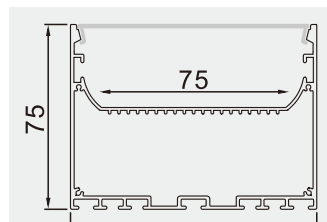

Description

size: Lx100x75mm
 Material: 6063-T5
 Surface: Silver / black / white Anodized
 PC cover: Milky white/black/acrylic matte
 Apply: LED Strips and PCB 75mm



plastic end cap spring clip suspended wire



10235A

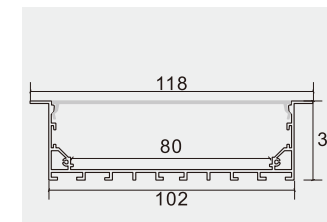

Description

size: Lx118x35mm
 Material: 6063-T5
 Surface: Silver / black / white Anodized
 PC cover: Milky white/black/acrylic matte
 Apply: LED Strips and PCB 80mm



plastic end cap spring clip



12035M

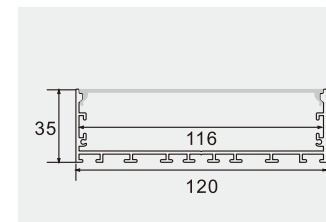

Description

size: Lx120x35mm
 Material: 6063-T5
 Surface: Silver / black / white Anodized
 PC cover: Milky white/black/acrylic matte
 Apply: LED Strips and PCB 116mm



plastic end cap spring clip suspended wire

ALUMINUM PROFILE



12035A

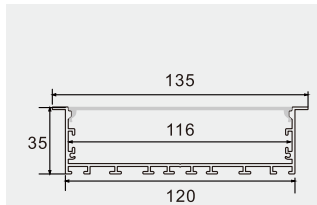

Description

size: Lx135x35mm
 Material: 6063-T5
 Surface: Silver / black / white Anodized
 PC cover: Milky white/black/acrylic matte
 Apply: LED Strips and PCB 116mm



plastic end cap spring clip



12040M

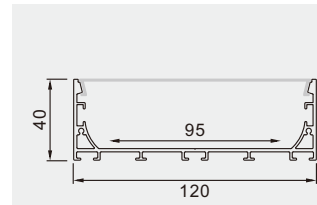

Description

size: Lx120x40mm
 Material: 6063-T5
 Surface: Silver / black / white Anodized
 PC cover: Milky white/black/acrylic matte
 Apply: LED Strips and PCB 95mm



plastic end cap spring clip suspended wire



15035M

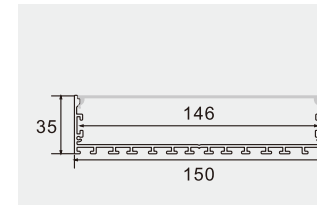

Description

size: Lx150x35mm
 Material: 6063-T5
 Surface: Silver / black / white Anodized
 PC cover: Milky white/black/acrylic matte
 Apply: LED Strips and PCB 146mm



plastic end cap spring clip suspended wire



15035A

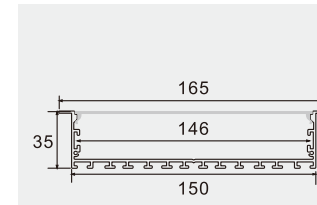

Description

size: Lx165x35mm
 Material: 6063-T5
 Surface: Silver / black / white Anodized
 PC cover: Milky white/black/acrylic matte
 Apply: LED Strips and PCB 146mm



plastic end cap spring clip



12040A

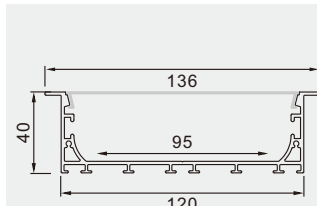

Description

size: Lx136x40mm
 Material: 6063-T5
 Surface: Silver / black / white Anodized
 PC cover: Milky white/black/acrylic matte
 Apply: LED Strips and PCB 95mm



plastic end cap spring clip



12085M

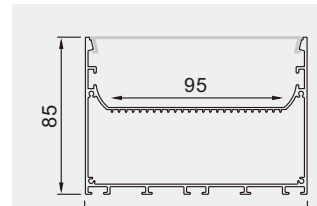

Description

size: Lx120x85mm
 Material: 6063-T5
 Surface: Silver / black / white Anodized
 PC cover: Milky white/black/acrylic matte
 Apply: LED Strips and PCB 95mm



plastic end cap spring clip suspended wire



15050M

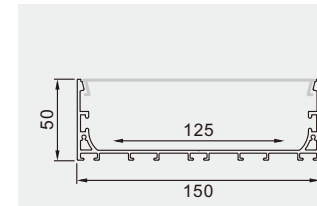

Description

size: Lx150x50mm
 Material: 6063-T5
 Surface: Silver / black / white Anodized
 PC cover: Milky white/black/acrylic matte
 Apply: LED Strips and PCB 125mm



plastic end cap spring clip suspended wire



15050A

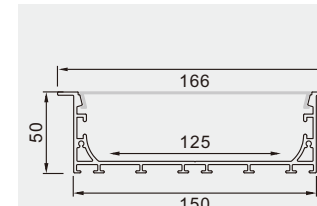

Description

size: Lx166x50mm
 Material: 6063-T5
 Surface: Silver / black / white Anodized
 PC cover: Milky white/black/acrylic matte
 Apply: LED Strips and PCB 125mm



plastic end cap spring clip

ALUMINUM PROFILE

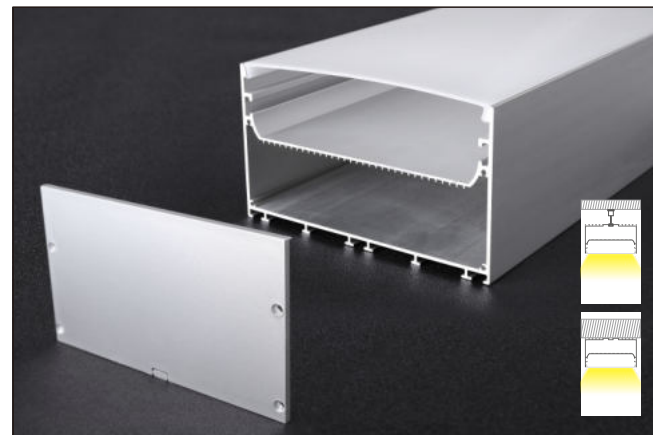

15085M

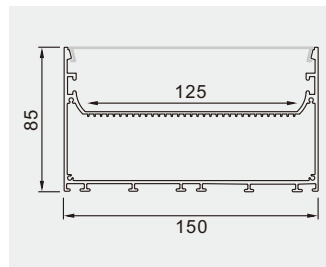

Description

size: Lx150x85mm
 Material: 6063-T5
 Surface: Silver / black / white Anodized
 PC cover: Milky white/black/acrylic matte
 Apply: LED Strips and PCB 125mm



plastic end cap spring clip suspended wire



20050M

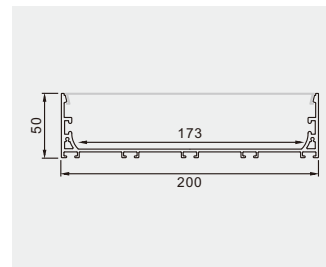

Description

size: Lx200x50mm
 Material: 6063-T5
 Surface: Silver / black / white Anodized
 PC cover: Milky white/black/acrylic matte
 Apply: LED Strips and PCB 173mm



plastic end cap spring clip suspended wire



20050A

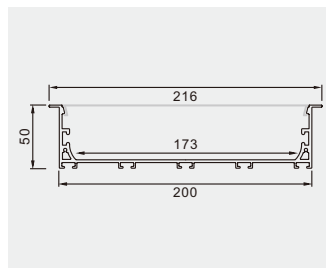

Description

size: Lx216x50mm
 Material: 6063-T5
 Surface: Silver / black / white Anodized
 PC cover: Milky white/black/acrylic matte
 Apply: LED Strips and PCB 173mm



plastic end cap spring clip

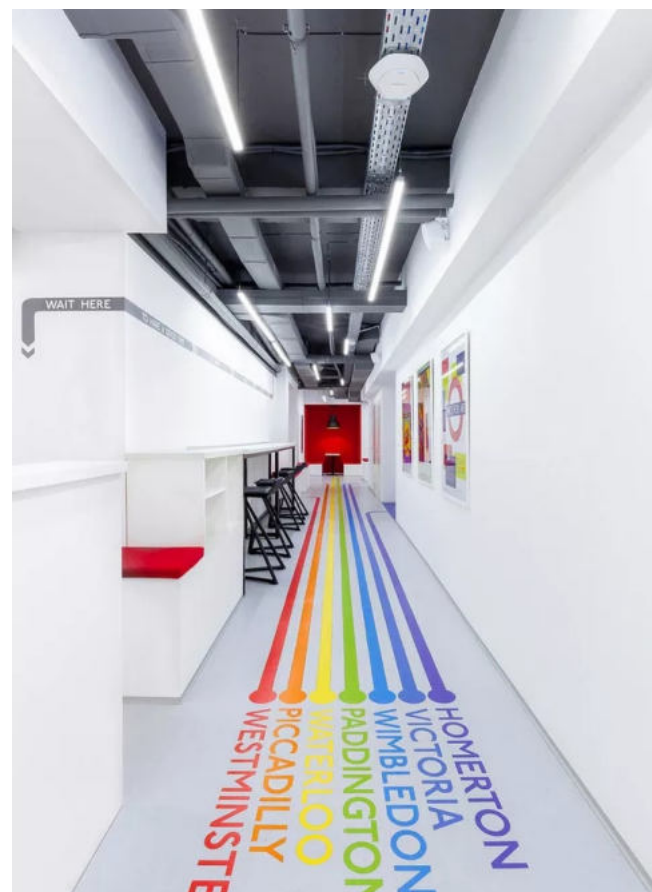

UP AND DOWN SHELF

»»» P37-P38



2022
 NEW STYLE

ALUMINUM PROFILE



2109M

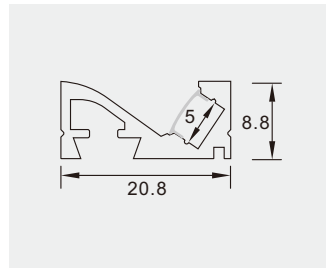

Description

size: Lx20.8x8.8mm
 Material: 6063-T5
 Surface: Silver / black / white Anodized
 PC cover: Milky white/black/acrylic matte
 Apply: LED Strips and PCB 5mm



plastic end cap spring clip



2109A

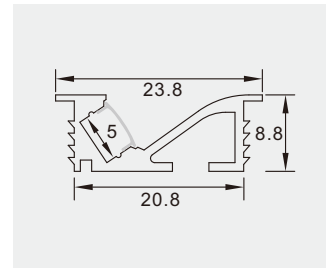

Description

size: Lx23.8x8.8mm
 Material: 6063-T5
 Surface: Silver / black / white Anodized
 PC cover: Milky white/black/acrylic matte
 Apply: LED Strips and PCB 5mm



plastic end cap spring clip



2028

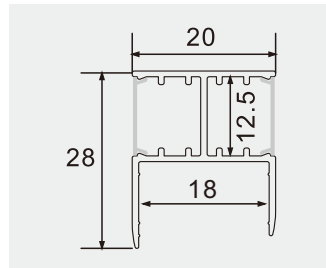

Description

size: Lx20x28mm
 Material: 6063-T5
 Surface: Silver / black / white Anodized
 PC cover: Milky white/black/acrylic matte
 Apply: LED Strips and PCB 12mm



3Dlinear light aluminum profile

»»» P39-P40



2022
 NEW STYLE

ALUMINUM PROFILE



Ø30

Description
 size: LxØ30mm
 Material: 6063-T5
 Surface: Silver / black / white Anodized
 PC cover: Milky white/black/acrylic matte
 Apply: LED Strips and PCB 20mm

plastic end cap spring clip

Ø60

Description
 size: LxØ60mm
 Material: 6063-T5
 Surface: Silver / black / white Anodized
 PC cover: Milky white/black/acrylic matte
 Apply: LED Strips and PCB 30mm

plastic end cap spring clip suspended wire



4542S

Description
 size: Lx45x42mm
 Material: 6063-T5
 Surface: Silver / black / white Anodized
 PC cover: Milky white/black/acrylic matte
 Apply: LED Strips and PCB 35mm

metal end cap spring clip suspended wire

4542R

Description
 size: Lx45x42mm
 Material: 6063-T5
 Surface: Silver / black / white Anodized
 PC cover: Milky white/black/acrylic matte
 Apply: LED Strips and PCB 35mm

metal end cap spring clip suspended wire

DRYWALL LED

»»» P41-P46

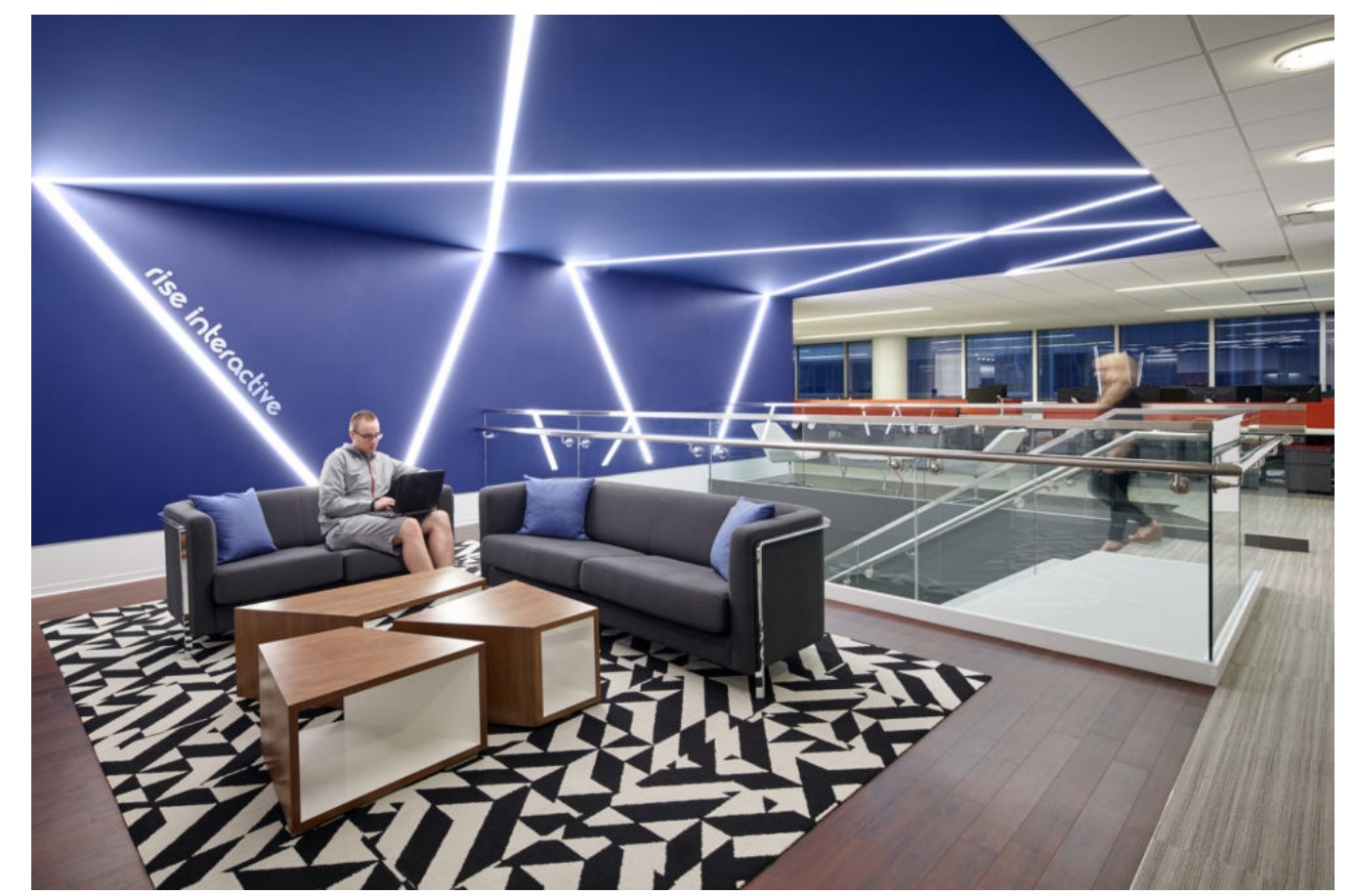

2022
NEW STYLE

ALUMINUM PROFILE



704

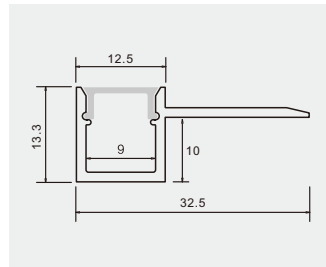

Description

size:Lx32.5x13.3mm
Material:6063-T5
Surface:Silver / black / white Anodized
PC cover:Milky white/black/acrylic matte
Apply:LED Strips and PCB 9mm



plastic end cap

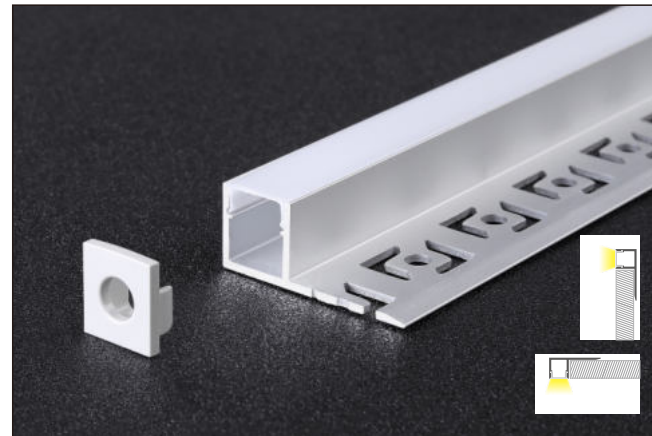

702

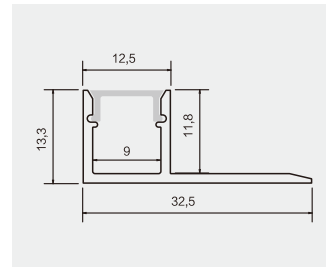

Description

size:Lx32.5x13.3mm
Material:6063-T5
Surface:Silver / black / white Anodized
PC cover:Milky white/black/acrylic matte
Apply:LED Strips and PCB 9mm

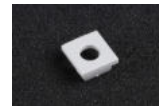

plastic end cap

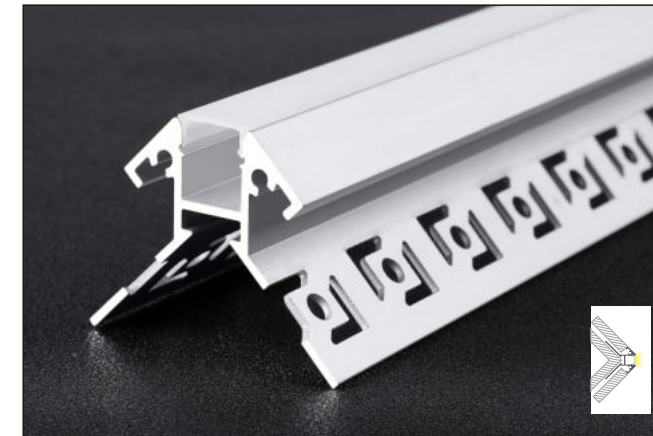

707M

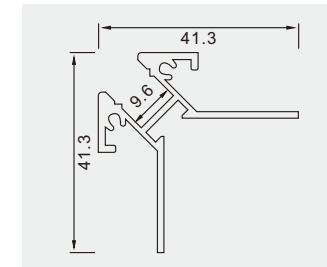

Description

size:Lx41.3x41.3mm
Material:6063-T5
Surface:Silver / black / white Anodized
PC cover:Milky white/black/acrylic matte
Apply:LED Strips and PCB 9mm

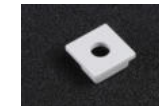

plastic end cap



707F

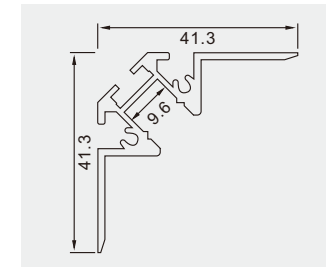

Description

size:Lx48x27mm
Material:6063-T5
Surface:Silver / black / white Anodized
PC cover:Milky white/black/acrylic matte
Apply:LED Strips and PCB 9mm

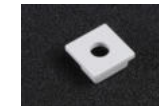

plastic end cap

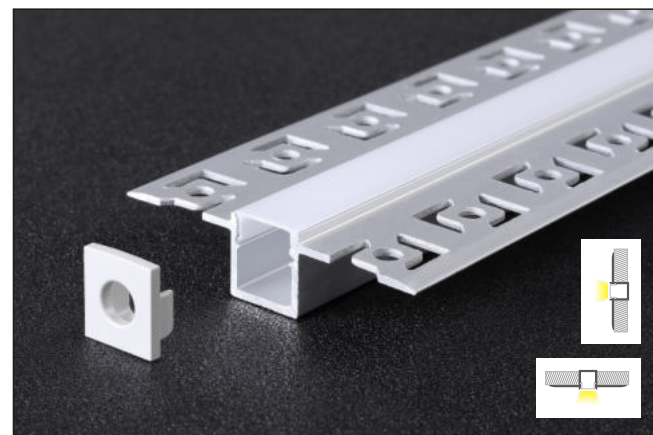

639

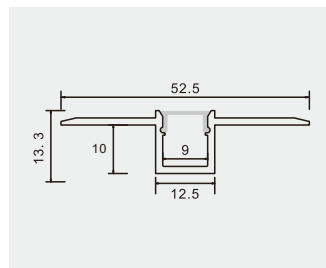

Description

size:Lx52.5x13.3mm
Material:6063-T5
Surface:Silver / black / white Anodized
PC cover:Milky white/black/acrylic matte
Apply:LED Strips and PCB 9mm



plastic end cap

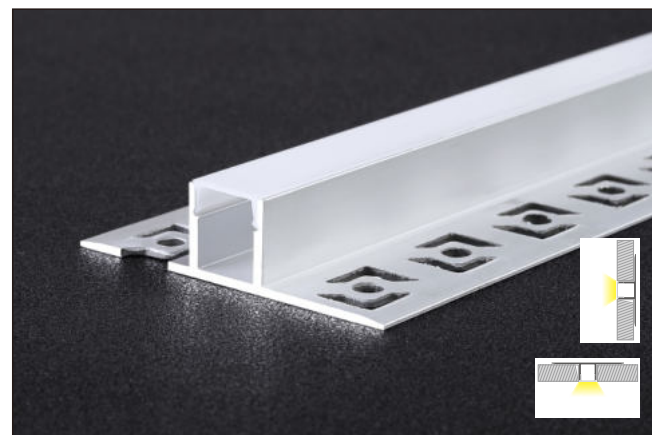

703

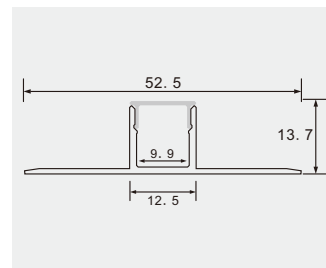

Description

size:Lx52.5x13.7mm
Material:6063-T5
Surface:Silver / black / white Anodized
PC cover:Milky white/black/acrylic matte
Apply:LED Strips and PCB 9.9mm



plastic end cap

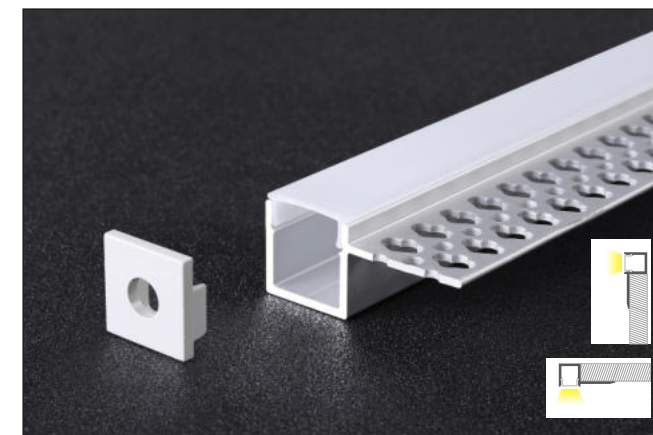

701F

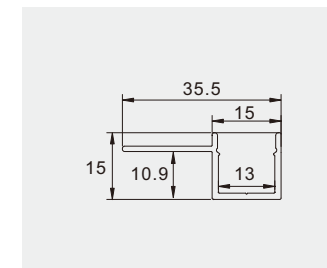

Description

size:Lx35.5x15mm
Material:6063-T5
Surface:Silver / black / white Anodized
PC cover:Milky white/black/acrylic matte
Apply:LED Strips and PCB 12mm



plastic end cap

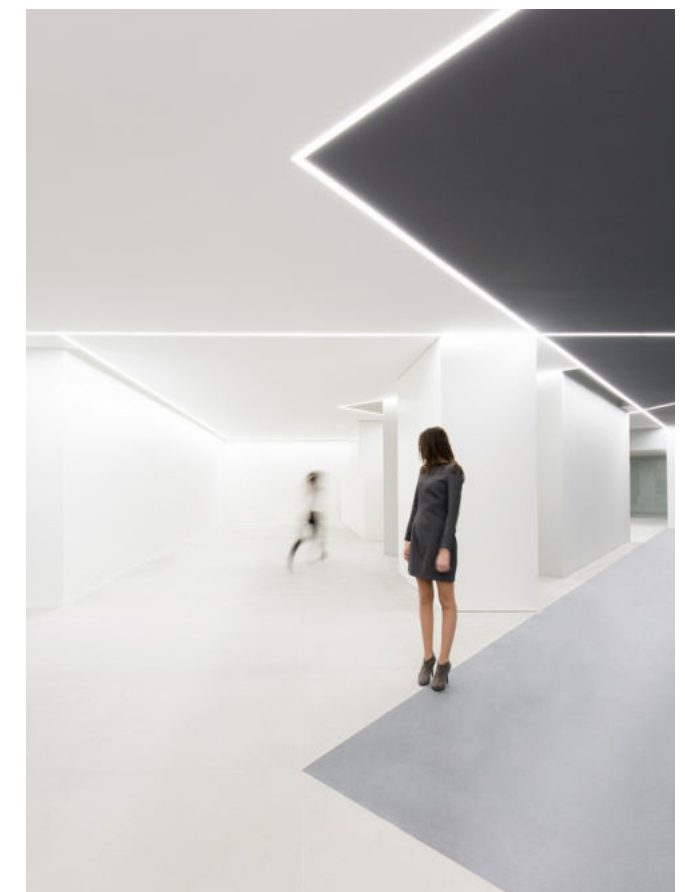

ALUMINUM PROFILE

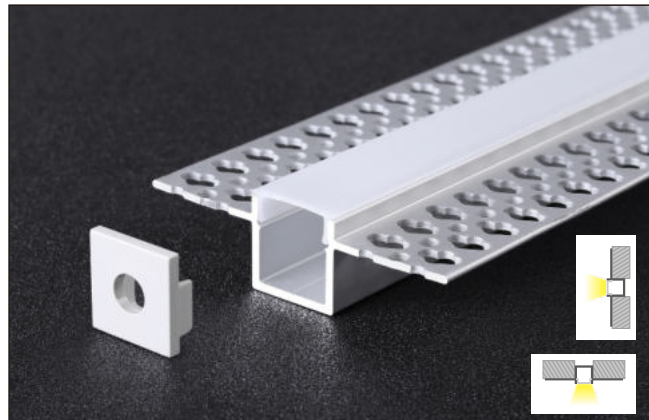

639

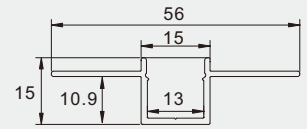

Desciption

size:Lx56x15mm
Material:6063-T5
Surface:Silver / black / white Anodized
PC cover:Milky white/black/acrylic matte
Apply:LED Strips and PCB 12mm

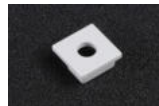

plastic end cap

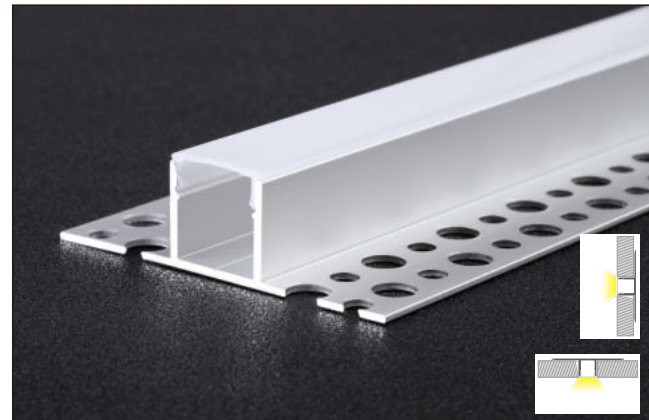

639

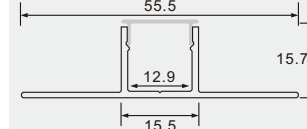

Desciption

size:Lx55.5x15.7mm
Material:6063-T5
Surface:Silver / black / white Anodized
PC cover:Milky white/black/acrylic matte
Apply:LED Strips and PCB 12mm

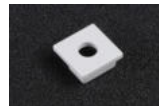

plastic end cap



2013

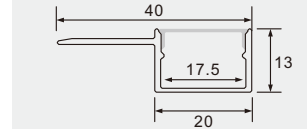

Desciption

size:Lx40x13mm
Material:6063-T5
Surface:Silver / black / white Anodized
PC cover:Milky white/black/acrylic matte
Apply:LED Strips and PCB 17.5mm



plastic end cap

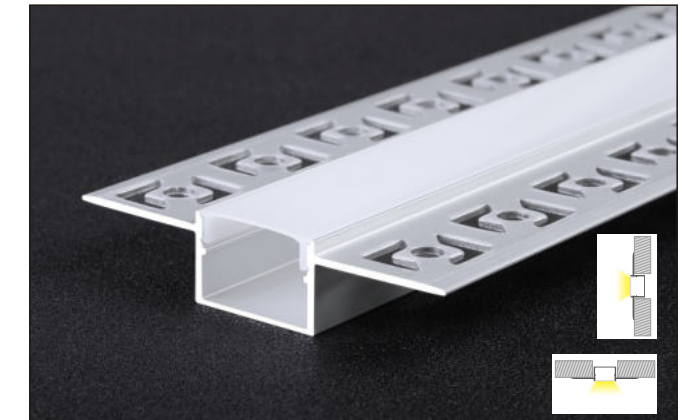

2013

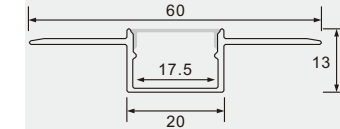

Desciption

size:Lx60x13mm
Material:6063-T5
Surface:Silver / black / white Anodized
PC cover:Milky white/black/acrylic matte
Apply:LED Strips and PCB 17.5mm



plastic end cap

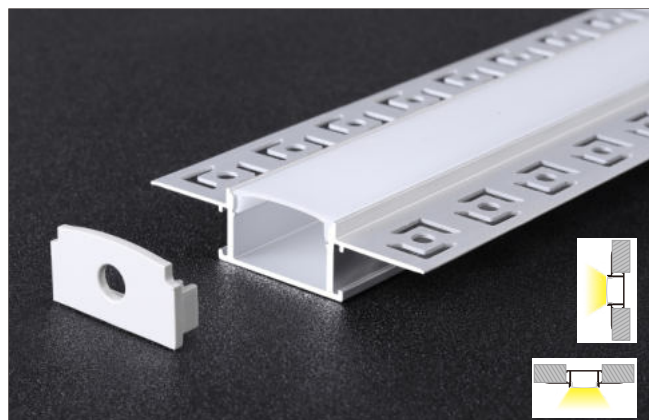

6114

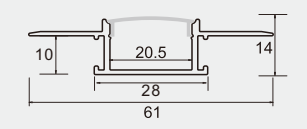

Desciption

size:Lx61x14mm
Material:6063-T5
Surface:Silver / black / white Anodized
PC cover:Milky white/black/acrylic matte
Apply:LED Strips and PCB 20mm



plastic end cap

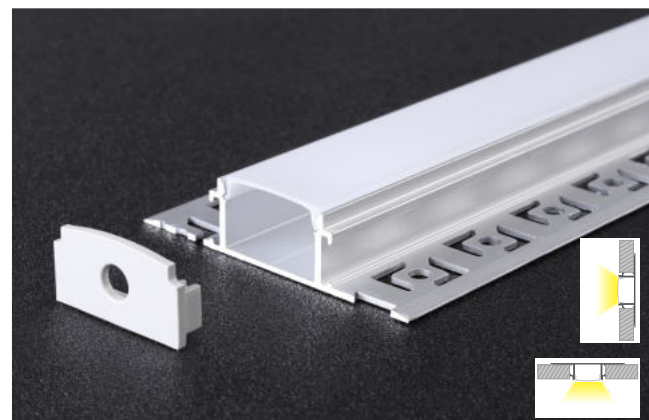

6114A

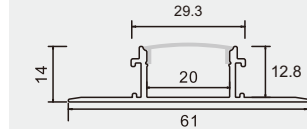

Desciption

size:Lx61x14mm
Material:6063-T5
Surface:Silver / black / white Anodized
PC cover:Milky white/black/acrylic matte
Apply:LED Strips and PCB 20mm



plastic end cap

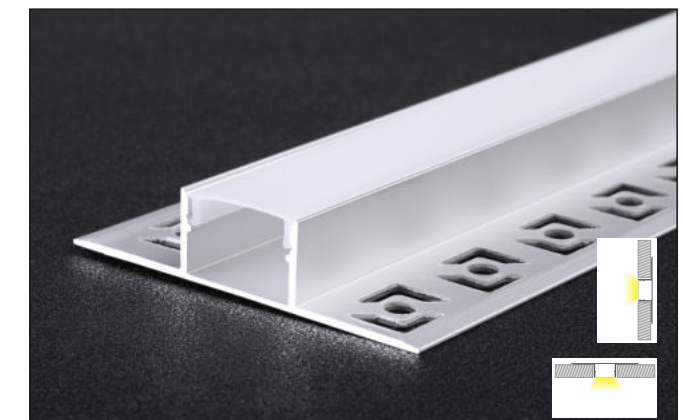
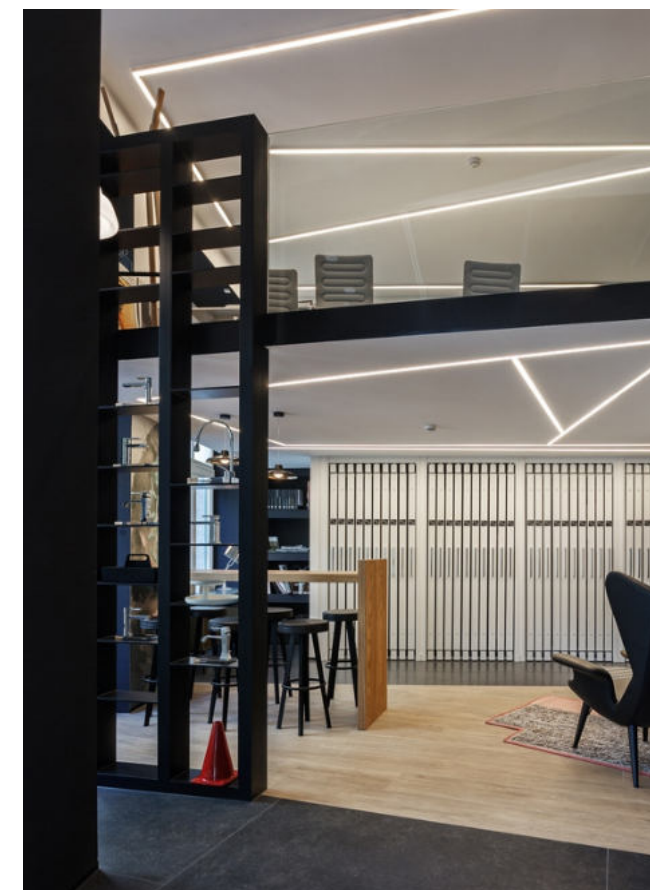

2013

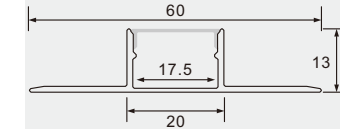

Desciption

size:Lx60x13mm
Material:6063-T5
Surface:Silver / black / white Anodized
PC cover:Milky white/black/acrylic matte
Apply:LED Strips and PCB 17.5mm



plastic end cap

ALUMINUM PROFILE



3020

Description
 size:Lx50x20mm
 Material:6063-T5
 Surface:Silver / black / white Anodized
 PC cover:Milky white/black/acrylic matte
 Apply:LED Strips and PCB 28mm

plastic end cap

3020

Description
 size:Lx70x20mm
 Material:6063-T5
 Surface:Silver / black / white Anodized
 PC cover:Milky white/black/acrylic matte
 Apply:LED Strips and PCB 28mm

plastic end cap

9620

Description
 size:Lx96x20mm
 Material:6063-T5
 Surface:Silver / black / white Anodized
 PC cover:Milky white/black/acrylic matte
 Apply:LED Strips and PCB 45mm

plastic end cap

Ground Linear light

»»» P47-P49



2022
NEW STYLE

ALUMINUM PROFILE



632-1

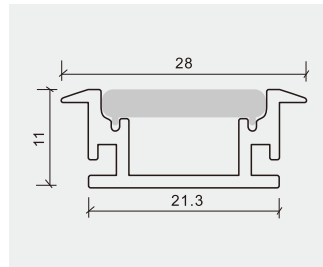

Description

size:Lx28x11mm
Material:6063-T5
Surface:Silver / black / white Anodized
PC cover:Milky white/black/acrylic matte
Apply:LED Strips and PCB 12mm



plastic end cap

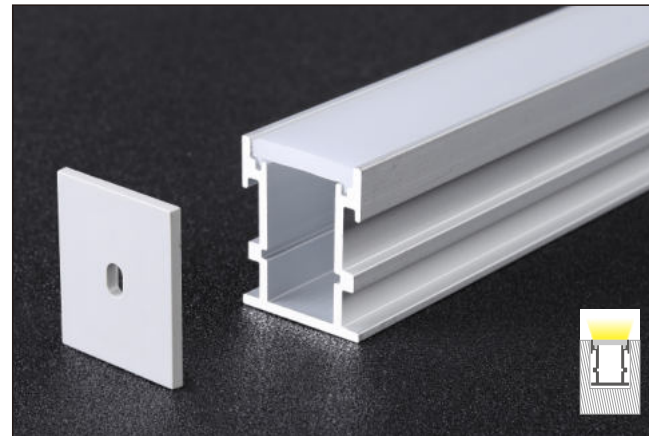

632

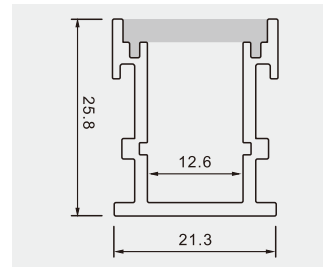

Description

size:Lx21.3x25.8mm
Material:6063-T5
Surface:Silver / black / white Anodized
PC cover:Milky white/black/acrylic matte
Apply:LED Strips and PCB 12mm



plastic end cap

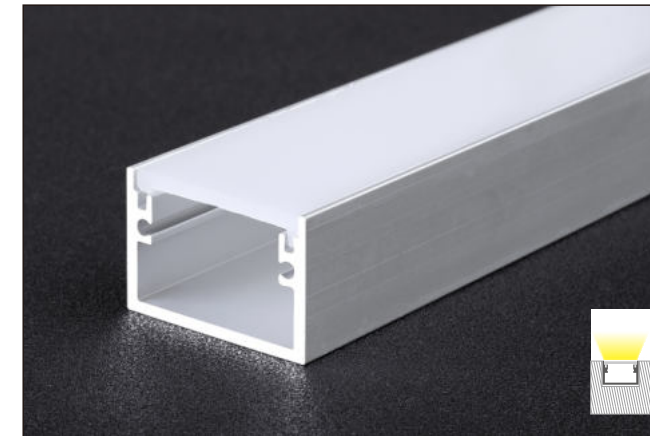

3020M

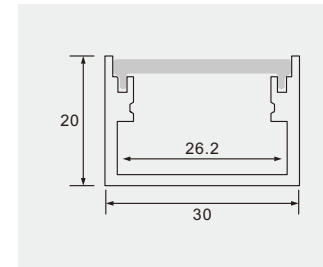

Description

size:Lx30x20mm
Material:6063-T5
Surface:Silver / black / white Anodized
PC cover:Milky white/black/acrylic matte
Apply:LED Strips and PCB 26mm



plastic end cap

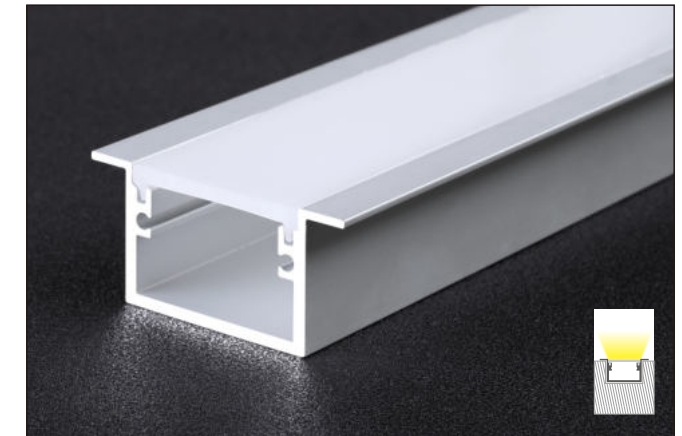

3020A

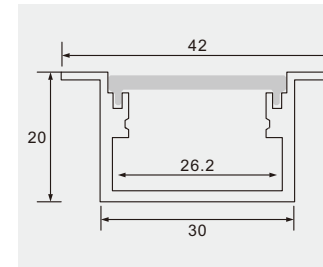

Description

size:Lx42x20mm
Material:6063-T5
Surface:Silver / black / white Anodized
PC cover:Milky white/black/acrylic matte
Apply:LED Strips and PCB 26mm



plastic end cap

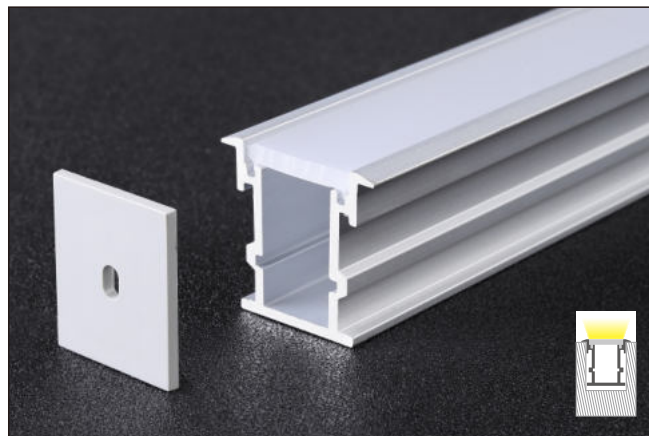

632A

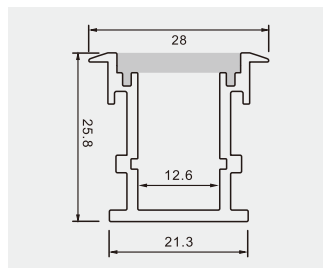

Description

size:Lx28x25.8mm
Material:6063-T5
Surface:Silver / black / white Anodized
PC cover:Milky white/black/acrylic matte
Apply:LED Strips and PCB 12mm



plastic end cap



5032M

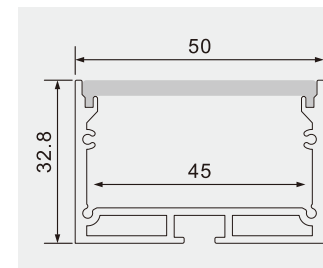

Description

size:Lx50x32.8mm
Material:6063-T5
Surface:Silver / black / white Anodized
PC cover:Milky white/black/acrylic matte
Apply:LED Strips and PCB 45mm



metal end cap



spring clip



5032A

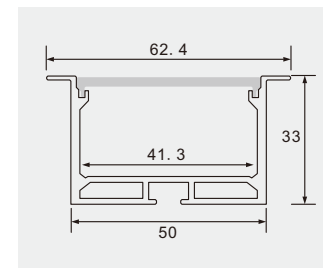

Description

size:Lx62.4x33mm
Material:6063-T5
Surface:Silver / black / white Anodized
PC cover:Milky white/black/acrylic matte
Apply:LED Strips and PCB 41mm



metal end cap



spring clip

ALUMINUM PROFILE

Wall Washer Light

»»» P50-P55



2022
NEW STYLE

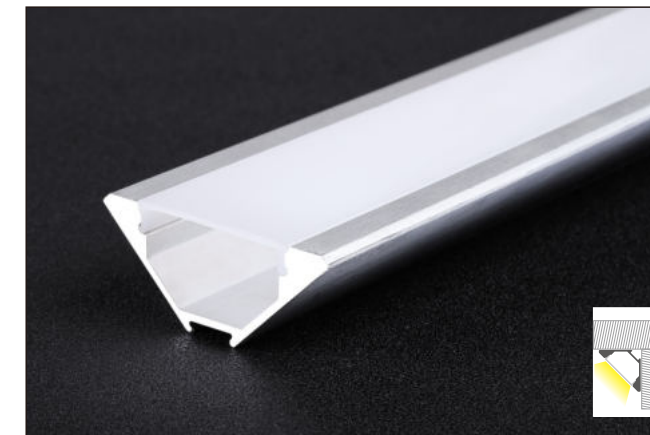

3030-L

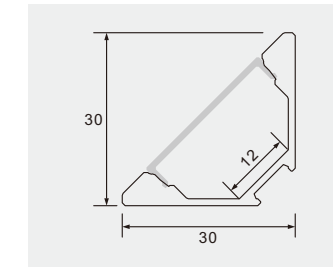

Description

size:Lx30x30mm
Material:6063-T5
Surface:Silver / black / white Anodized
PC cover:Milky white/black/acrylic matte
Apply:LED Strips and PCB 12mm



5050-L

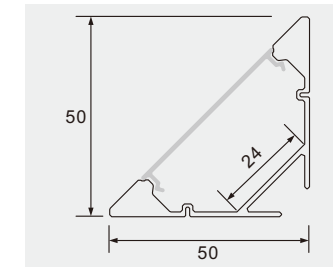

Description

size:Lx50x50mm
Material:6063-T5
Surface:Silver / black / white Anodized
PC cover:Milky white/black/acrylic matte
Apply:LED Strips and PCB 24mm

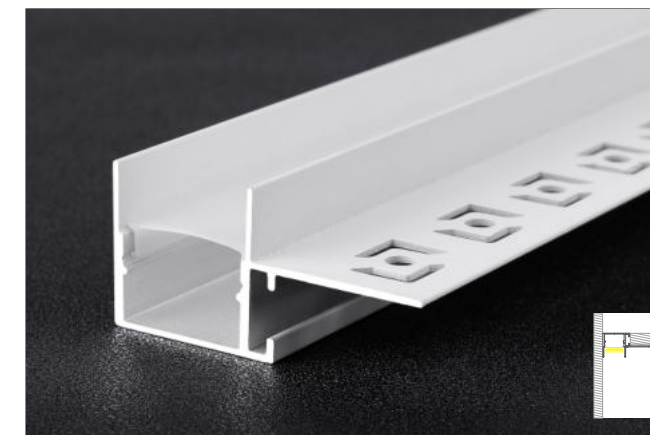

101

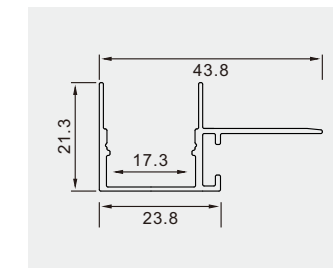

Description

size:Lx43.8x21.3mm
Material:6063-T5
Surface:Silver / black / white Anodized
PC cover:Milky white/black/acrylic matte
Apply:LED Strips and PCB 17mm



Lighting Source/Driver

LED strip light



LT-2835W120R-W24
 Input:DC12V / 24V
 Power:15W/m
 LED:2835 120pcs/m
 PCB width:8mm
 Size:5m/roll
 CCT:3000K/4000K/6000K
 RA:RA90

MCPCB lighting



LT-2835W144Y-W24
 Input:DC12V / 24V
 Power:16W/pcs
 LED:2835 144led/pcs
 Width:12mm
 Size:1000mm
 CCT:3000K/4000K/6000K
 RA:RA90

MeanWell Driver



LRS-35 CV 12V/24V/48V



LRS-50 CV 12V/24V/48V



LRS-75 CV 12V/24V/48V



LRS-100 CV 12V/24V/48V



LRS-150 CV 12V/24V/48V



LRS-200 CV 12V/24V/48V



LRS-350 CV 12V/24V/48V

Magnet inside driver



KR-100W CV 48V



KR-200W CV 48V

ACCESSORIES

CORNER



PC: 509corner
 SIZE:17.4*7MM



PC: 613corner
 SIZE:17.2*14.4MM



PC: 601corner
 SIZE:15.8*15.8MM

CONNECTION

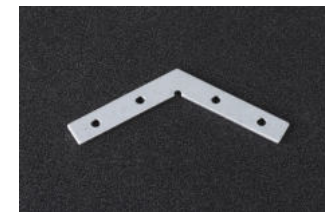

120
 50mm*10mm*2mm



135
 50mm*10mm*2mm



180
 100mm*10mm*2mm

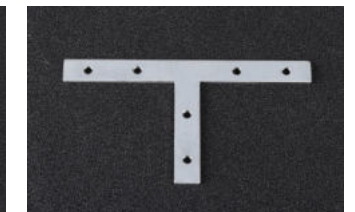

T
 100mm*10mm*2mm

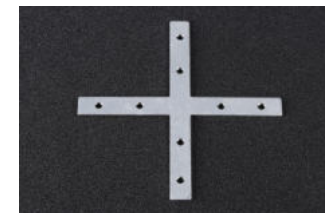

100mm*10mm*2mm

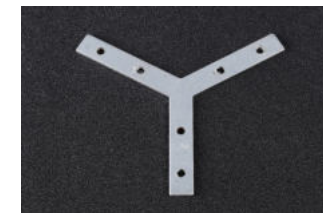

Y
 100mm*10mm*2mm



90
 50mm*10mm*2mm



90
 50mm*10mm*2mm

WIRE,CLIP,SPRING



CLIP



WIRE



SPRING



10CM SPRING



7CM SPRING



5CM SPRING



4CM SPRING



3CM SPRING

ALUMINUM PROFILE



102

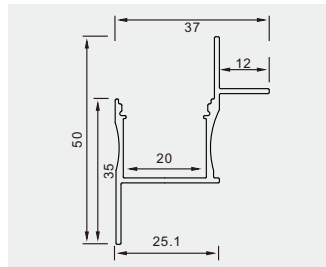

Description

size:Lx37x50mm
Material:6063-T5
Surface:Silver / black / white Anodized
PC cover:Milky white/black/acrylic matte
Apply:LED Strips and PCB 20mm



103

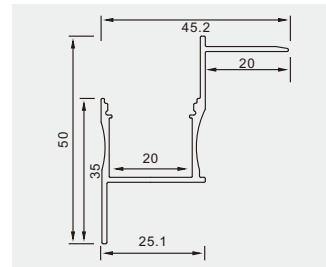

Description

size:Lx45.2x50mm
Material:6063-T5
Surface:Silver / black / white Anodized
PC cover:Milky white/black/acrylic matte
Apply:LED Strips and PCB 20mm

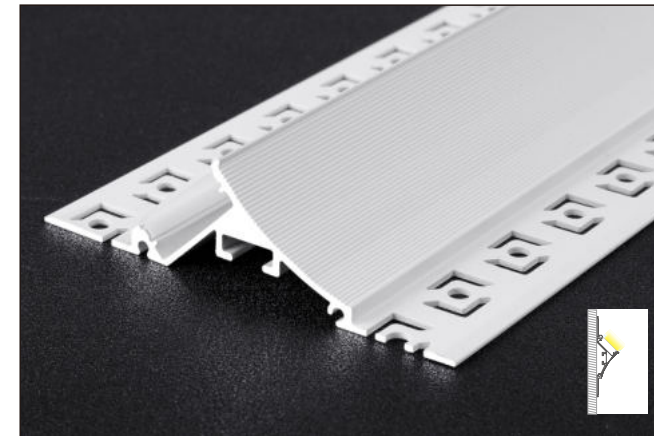

105

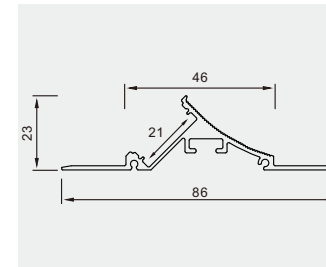

Description

size:Lx86x23mm
Material:6063-T5
Surface:Silver / black / white Anodized
PC cover:Milky white/black/acrylic matte
Apply:LED Strips and PCB 21mm

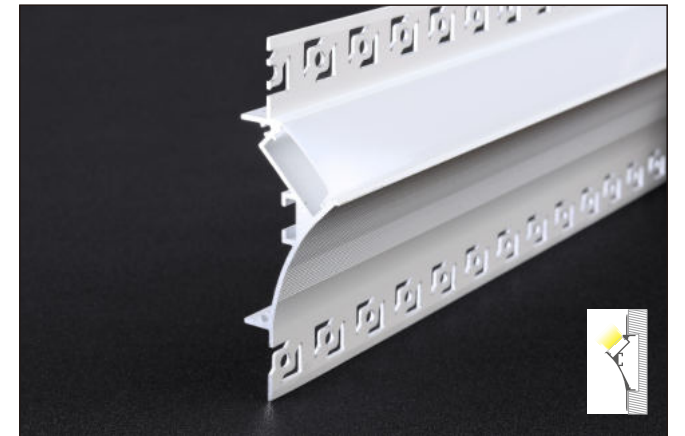

801

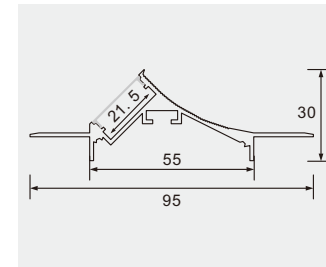

Description

size:Lx95x30mm
Material:6063-T5
Surface:Silver / black / white Anodized
PC cover:Milky white/black/acrylic matte
Apply:LED Strips and PCB 21mm

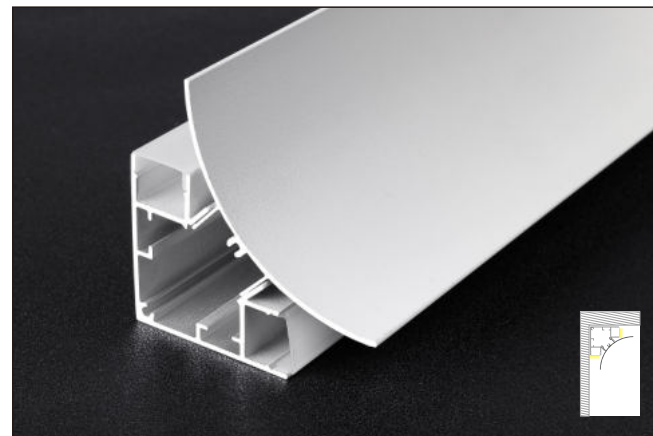

104

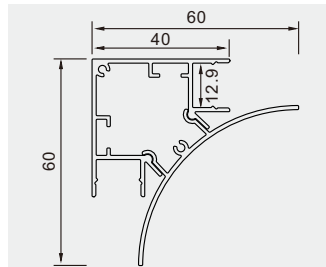

Description

size:Lx60x60mm
Material:6063-T5
Surface:Silver / black / white Anodized
PC cover:Milky white/black/acrylic matte
Apply:LED Strips and PCB 12mm

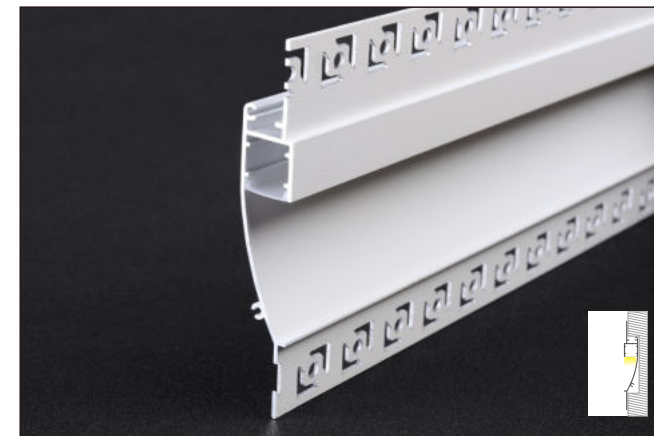

803

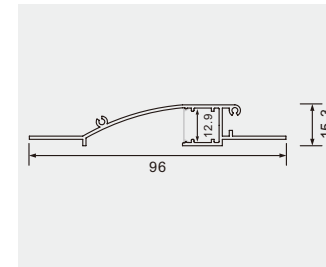

Description

size:Lx96x15.3mm
Material:6063-T5
Surface:Silver / black / white Anodized
PC cover:Milky white/black/acrylic matte
Apply:LED Strips and PCB 12mm

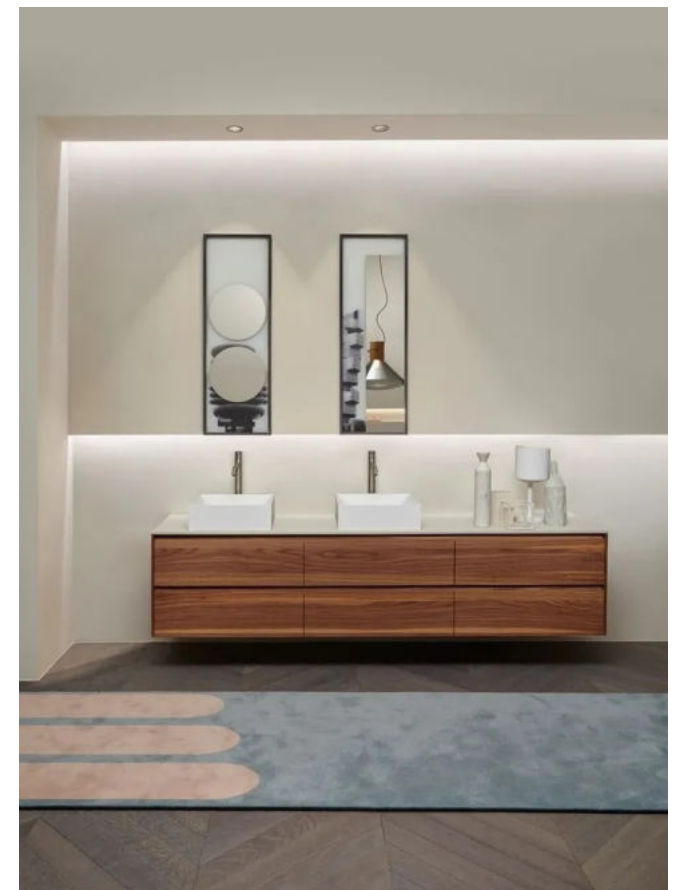

ALUMINUM PROFILE



106

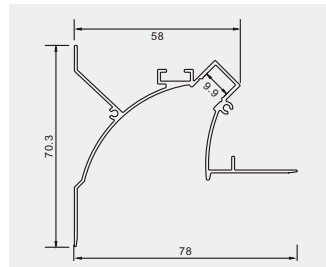

Description

size:Lx78x70.3mm
Material:6063-T5
Surface:Silver / black / white Anodized
PC cover:Milky white/black/acrylic matte
Apply:LED Strips and PCB 10mm



107

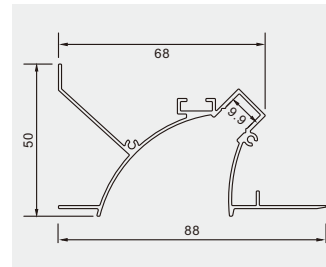

Description

size:Lx88x50mm
Material:6063-T5
Surface:Silver / black / white Anodized
PC cover:Milky white/black/acrylic matte
Apply:LED Strips and PCB 10mm



8878

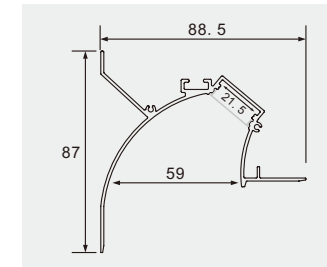

Description

size:Lx88.5x87mm
Material:6063-T5
Surface:Silver / black / white Anodized
PC cover:Milky white/black/acrylic matte
Apply:LED Strips and PCB 21mm

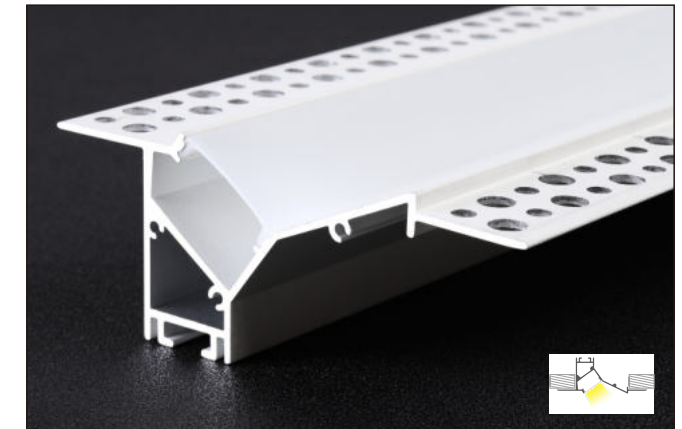

802

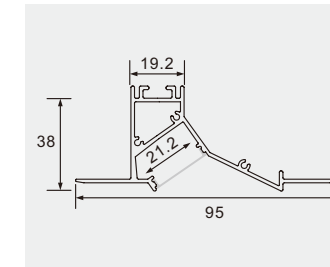

Description

size:Lx95x38mm
Material:6063-T5
Surface:Silver / black / white Anodized
PC cover:Milky white/black/acrylic matte
Apply:LED Strips and PCB 21mm



8858

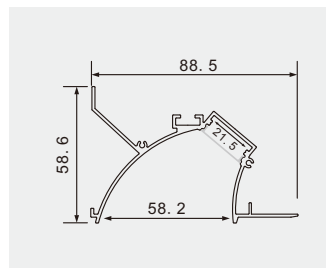

Description

size:Lx88.5x58.6mm
Material:6063-T5
Surface:Silver / black / white Anodized
PC cover:Milky white/black/acrylic matte
Apply:LED Strips and PCB 21mm



7158

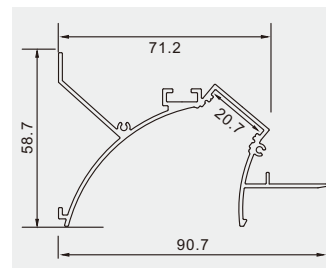

Description

size:Lx90.7x58.7mm
Material:6063-T5
Surface:Silver / black / white Anodized
PC cover:Milky white/black/acrylic matte
Apply:LED Strips and PCB 20mm



金属堵头
metal end cap

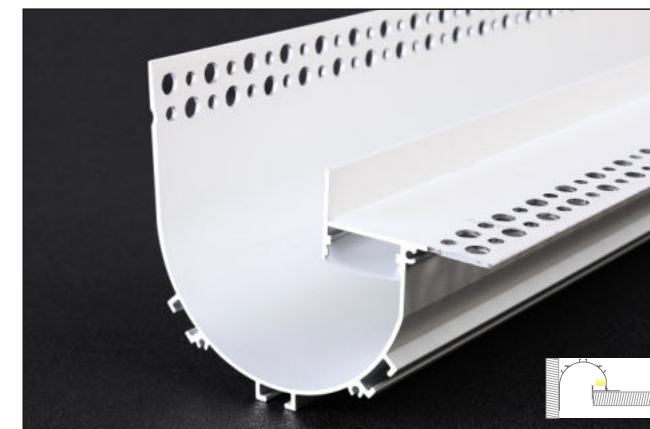

10486

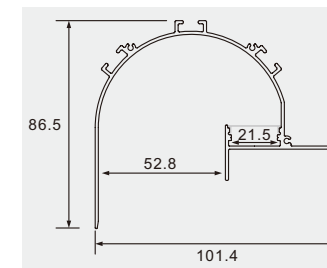

Description

size:Lx101.4x86.5mm
Material:6063-T5
Surface:Silver / black / white Anodized
PC cover:Milky white/black/acrylic matte
Apply:LED Strips and PCB 21mm



ALUMINUM PROFILE

Magnet Track light

Profile & lamps

»»» P56-P62

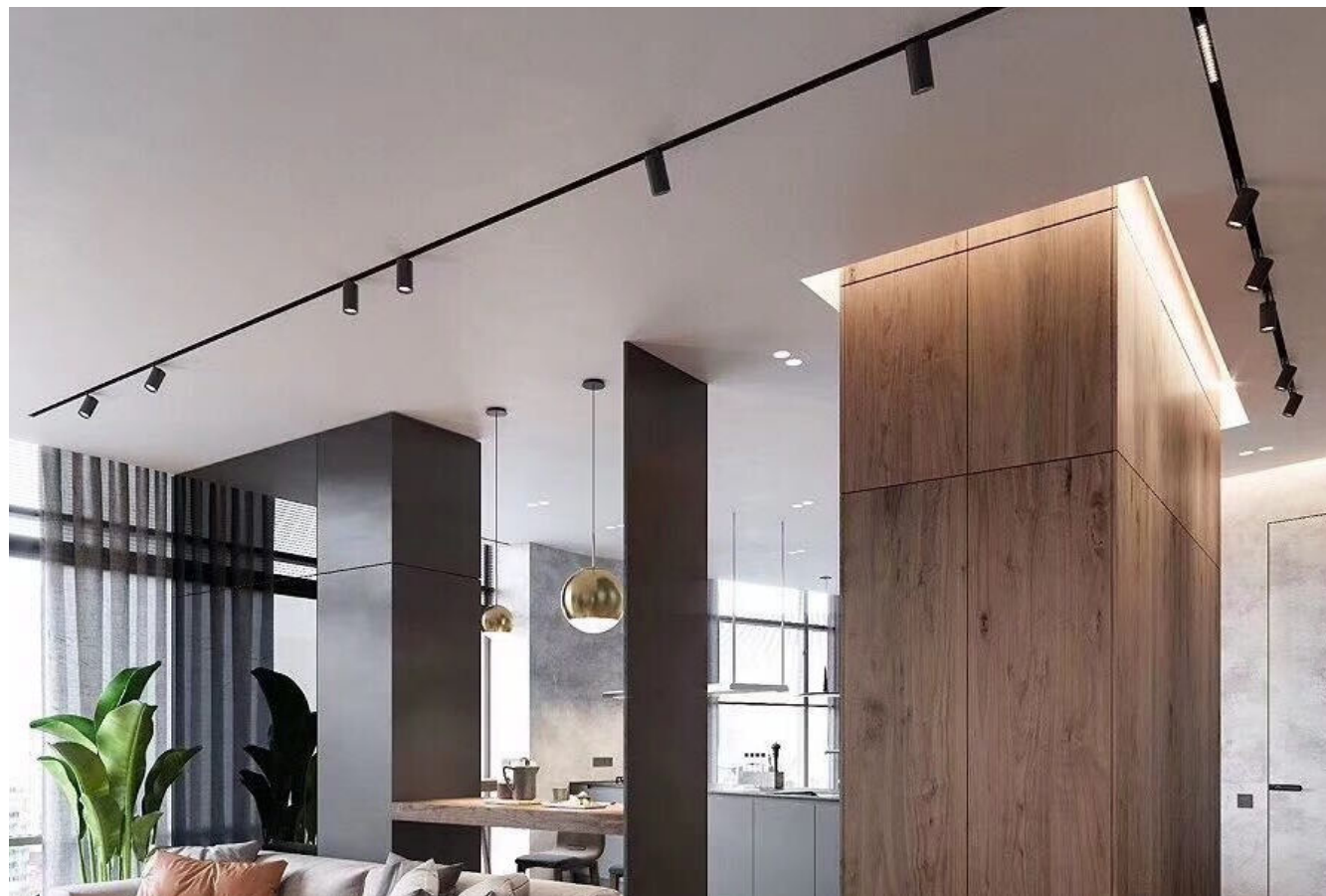

2022
NEW STYLE



2.0 plaster track

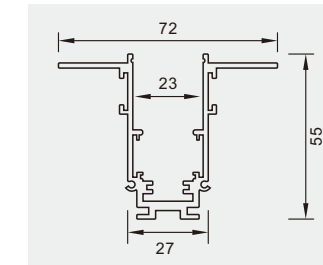

Description

size:Lx72x55mm
Material:6063-T5
Surface:Paint/oxidation black
Apply:2.0 Magnetic suction lamp



metal end cap

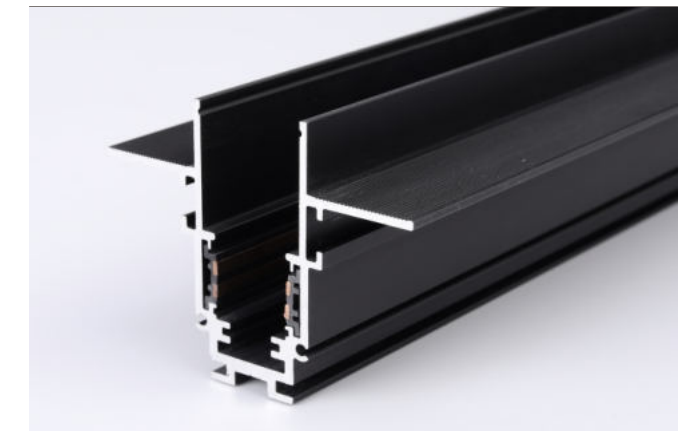

2.0 embedded track

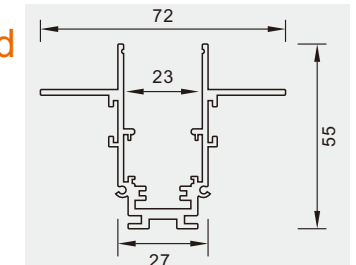

Description

size:Lx72x55mm
Material:6063-T5
Surface:Paint/oxidation black
Apply:2.0 Magnetic suction lamp



metal end cap

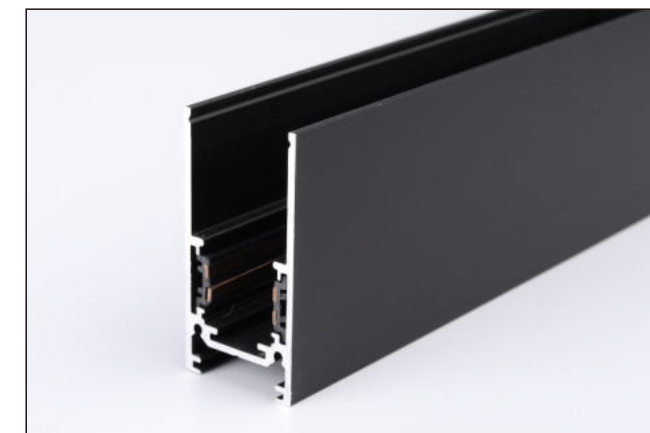

2.0 mounted track

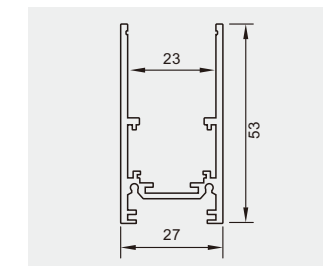

Description

size:Lx27x53mm
Material:6063-T5
Surface:Paint/oxidation black
Apply:2.0 Magnetic suction lamp



metal end cap

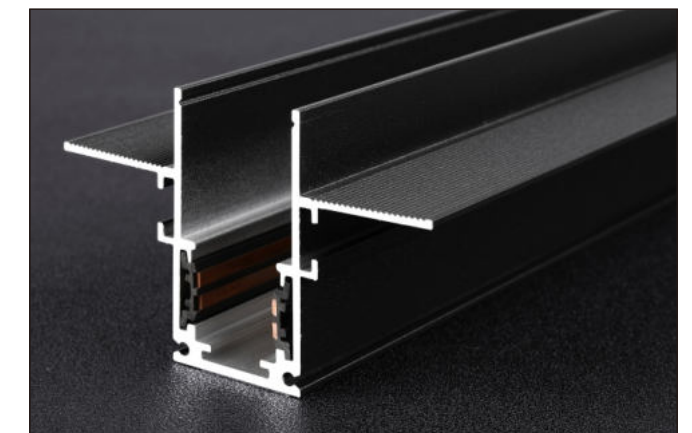

CX-01

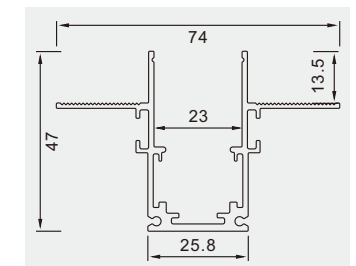

Description

size:Lx72x55mm
Material:6063-T5
Surface:Paint/oxidation black
Apply:2.0 Magnetic suction lamp



metal end cap

2.0Magnet System

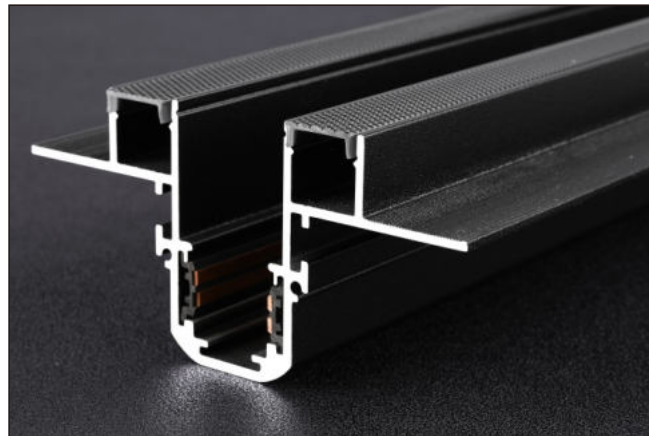

multi track embedded

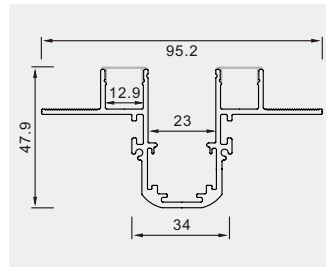

Description

size:Lx72x55mm
Material:6063-T5
Surface:Paint/oxidation black
Apply:2.0 Magnetic suction lamp



金属堵头
metal end cap



combined track embedded

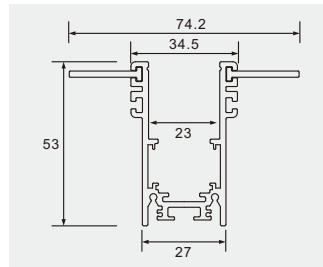

Description

size:Lx74x53mm
Material:6063-T5
Surface:Paint/oxidation black
Apply:2.0 Magnetic suction lamp



combined track embedded

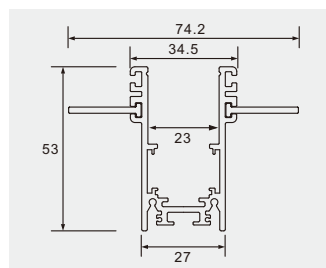

Description

size:Lx74x53mm
Material:6063-T5
Surface:Paint/oxidation black
Apply:2.0 Magnetic suction lamp

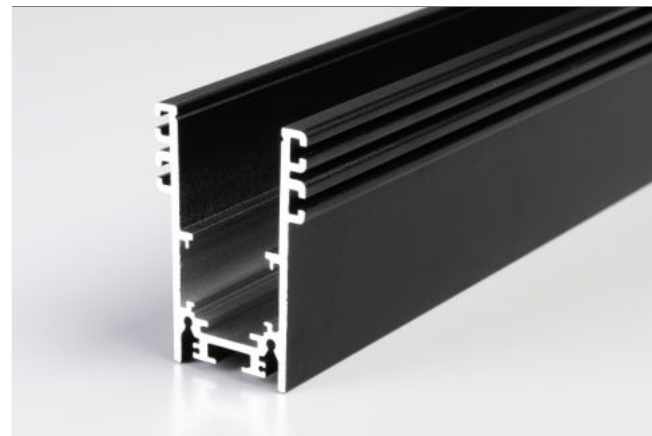

combined track mounted

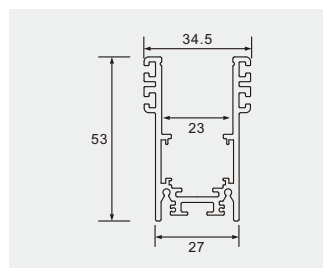

Description

size:Lx74x53mm
Material:6063-T5
Surface:Paint/oxidation black
Apply:2.0 Magnetic suction lamp

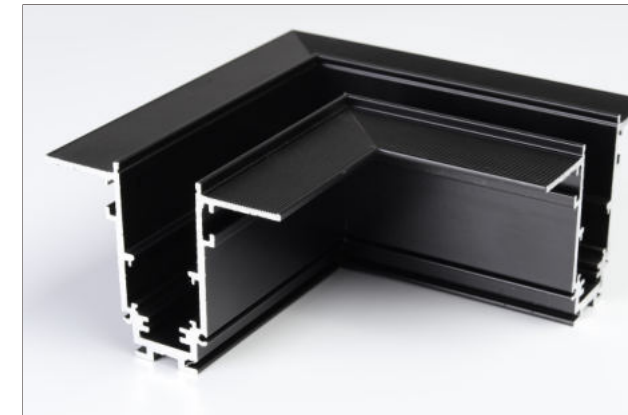

2.0 plaster track

size:Lx72x55mm
angel:90°
material:6063-T5
surface: black
version:2.0



2.0 plaster track

size:Lx72x55mm
angel:90°
material:6063-T5
surface: black
version:2.0

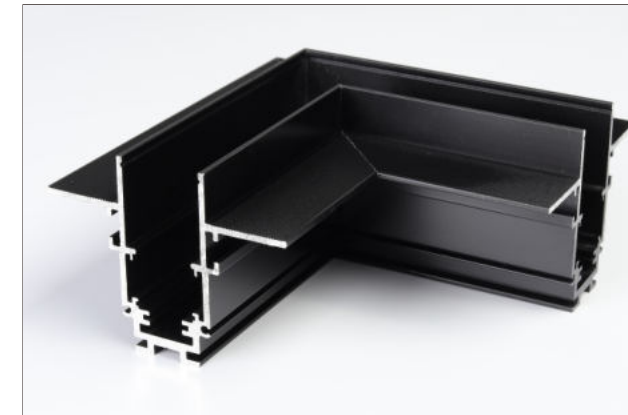

2.0 embedded track

size:Lx72x55mm
angel:90°
material:6063-T5
surface: black
version:2.0



2.0 embedded track

size:Lx72x55mm
angel:90°
material:6063-T5
surface: black
version:2.0

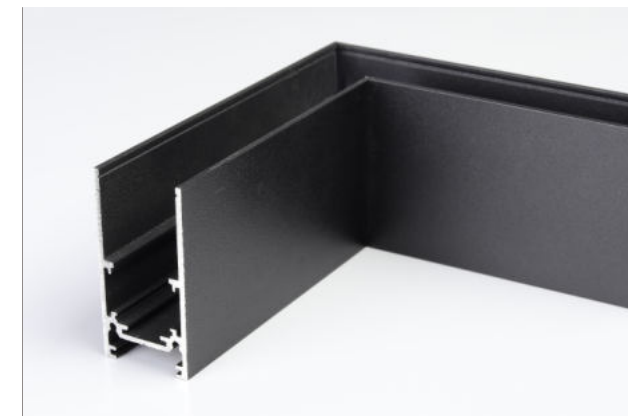

2.0 mounted track

size:Lx27x53mm
angel:90°
material:6063-T5
surface: black
version:2.0



2.0 mounted track

size:Lx27x53mm
angel:90°
material:6063-T5
surface: black
version:2.0

2.0 Magnet System



floodlight 30CM

power: 10W	surface: painting/anodized/black
size:291*22*44MM	material:6063-T5
lens: Dako	end cap: metal/black
ra: 90	



floodlight 60CM

power: 18W	surface: painting/anodized/black
size:601*22*44MM	material:6063-T5
lens:Dako	end cap: metal/black
ra: 90	



track light 12W

power: 12W	surface: painting/anodized/black
size:Φ65*L190MM	material: aluminium die casting
lens:Dako	end cap: metal/black
ra: 90	



Spot light 6w

power: 6W	surface: painting/anodized/black
size:130*22*106MM	material:6063-T5
lens: DAKO	end cap: metal/black
RA: 90	



grille light 6W

power: 6W	surface: painting/anodized/black
size:130*22*44MM	material:6063-T5
lens:Dako	end cap: metal/black
ra: 90	



grille light 12W

power: 12W	surface: painting/anodized/black
size:196*22*44MM	material:6063-T5
lens:Dako	end cap: metal/black
ra: 90	



spot light 12W

power: 12W	surface: painting/anodized/black
size:231*22*106MM	material:6063-T5
lens:Dako	end cap: metal/black
ra: 90	



input module

size:530*17*17MM



grille light 18W

power: 18W	surface: painting/anodized/black
size:291*22*44MM	material:6063-T5
lens:Dako	end cap: metal/black
ra: 90	



track light 7W

power: 7W	surface: painting/anodized/black
size:Φ50*L150MM	material:6063-T5
lens:Dako	end cap: metal/black
ra: 90	



connector module

size:202*17*17MM



corner module

size:368*17*17MM

ALUMINUM PROFILE

Bending Profile, Magnet Parts

>>> P62-P65



2022
NEW STYLE

Bending Magnet

minimum radius $R > 200\text{MM}$



floodlight 30CM



floodlight 60CM



spotlight 60cm



spotlight 120cm



track light 7W



track light 12w



spot light 1W



magnet light driver



input connector



connector



Embedded Track

Description

Size: Lx49x53mm
Material: 6063-T5
Surface: Black/white
Type: 2.0magnet
The minimum radius $R > 200\text{MM}$
Apply: magnet lighting

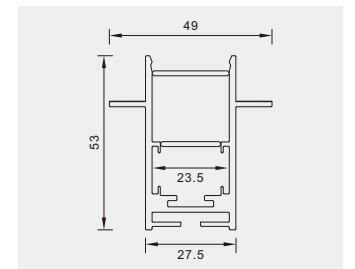

2.0Magnet System

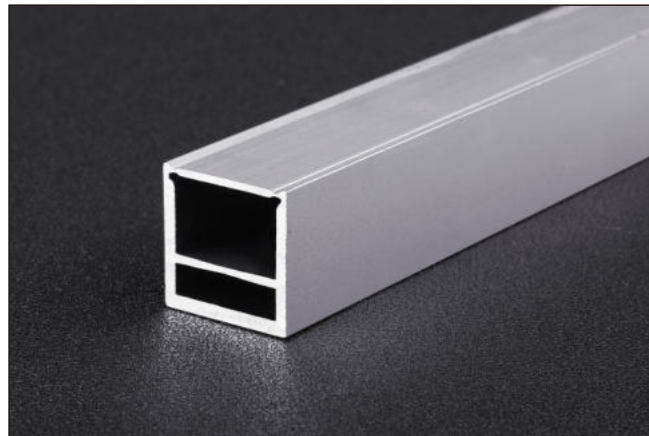

2020

Description

bending linear light

Size: Lx20x20mm
 Material: 6063-T5
 Surface: Silver/black/white/anodized
 PC COVER: milky white/ black/acrylic matte
 PCB width: 16MM
 The minimum radius R> 200MM
 Apply: LED and PCB 10MM

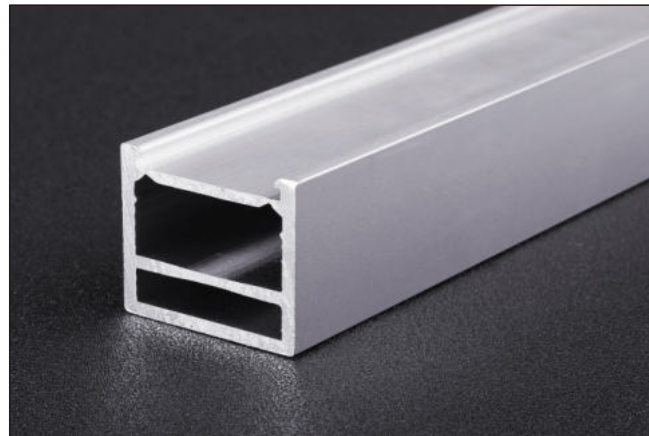
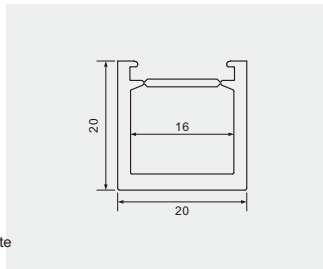

3020

Description

bending linear light

Size: Lx30x20mm
 Material: 6063-T5
 Surface: Silver/black/white/anodized
 PC COVER: milky white/ black/acrylic matte
 PCB width: 25MM
 The minimum radius R> 200MM
 Apply: LED and PCB 10MM

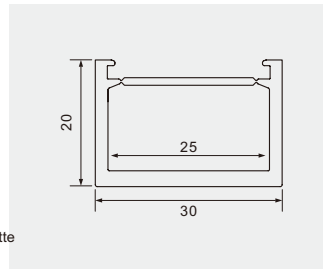

39A

Description

embedded bend profile

W40-200MM*H39MM
 The width can be customized
 The minimum radius R> 200MM
 Length: 3/6M
 Cover: PC(material 2.4*1.2m)

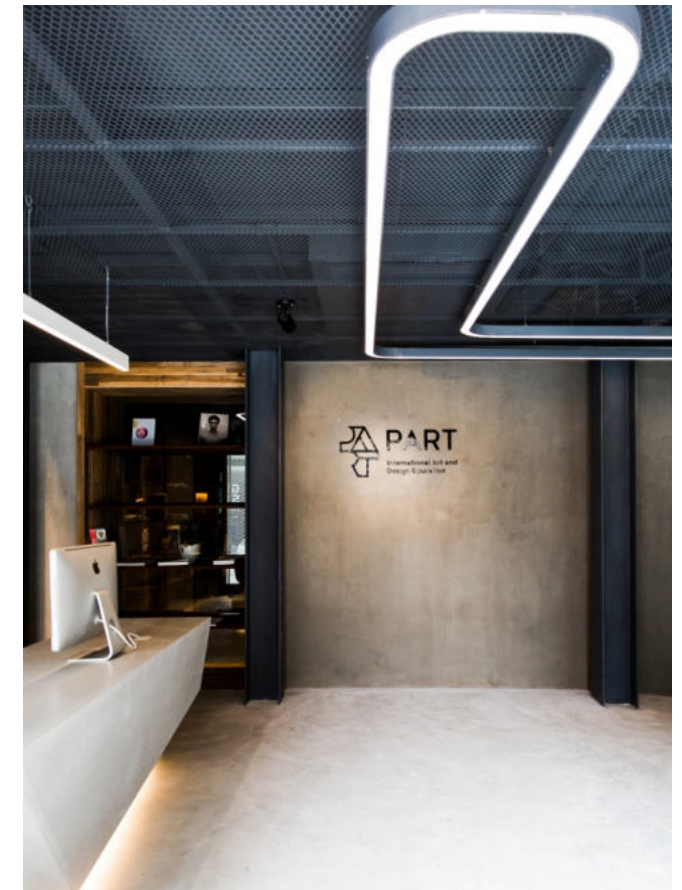
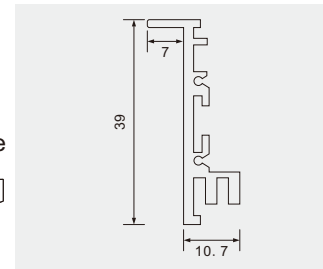
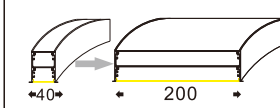

39M

Description

Mounted bend profile

W40-200MM*H39MM
 The width can be customized
 The minimum radius R> 200MM
 Length: 3/6M
 Cover: PC(material 2.4*1.2m)

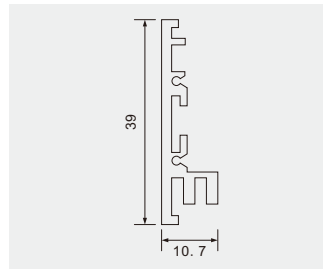
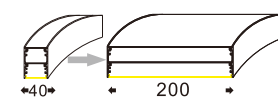

70M

Description

Mounted bend profile

W40-200MM*H70MM
 The width can be customized
 The minimum radius R> 200MM
 Length: 3/6M
 Cover: PC(material 2.4*1.2m)

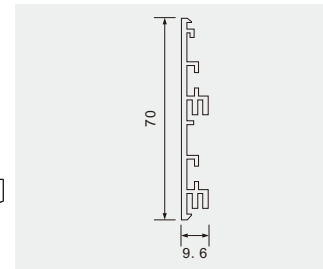
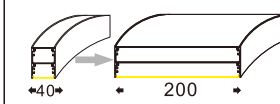

70A

Description

Embedded bend profile

W40-200MM*H70MM
 The width can be customized
 The minimum radius R> 200MM
 Length: 3/6M
 Cover: PC(material 2.4*1.2m)

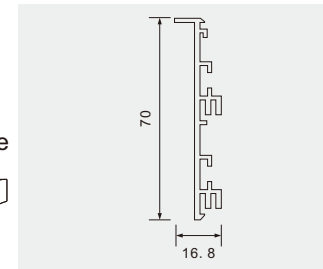
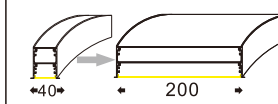

Lighting Source/Driver

LED strip light



LT-2835W120R-W24
 Input:DC12V / 24V
 Power:15W/m
 LED:2835 120pcs/m
 PCB width:8mm
 Size:5m/roll
 CCT:3000K/4000K/6000K
 RA:RA90

MCPCB lighting



LT-2835W144Y-W24
 Input:DC12V / 24V
 Power:16W/pcs
 LED:2835 144led/pcs
 Width:12mm
 Size:1000mm
 CCT:3000K/4000K/6000K
 RA:RA90

MeanWell Driver



LRS-35 CV 12V/24V/48V



LRS-50 CV 12V/24V/48V



LRS-75 CV 12V/24V/48V



LRS-100 CV 12V/24V/48V



LRS-150 CV 12V/24V/48V



LRS-200 CV 12V/24V/48V



LRS-350 CV 12V/24V/48V

Magnet inside driver



KR-100W CV 48V



KR-200W CV 48V

ACCESSORIES

CORNER



PC: 509corner
 SIZE:17.4*7MM



PC: 613corner
 SIZE:17.2*14.4MM



PC: 601corner
 SIZE:15.8*15.8MM

CONNECTION



120
 50mm*10mm*2mm

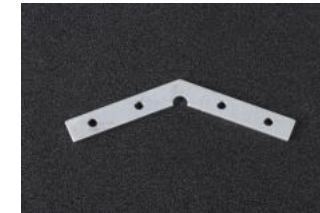

135
 50mm*10mm*2mm

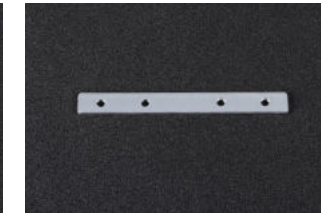

180
 100mm*10mm*2mm

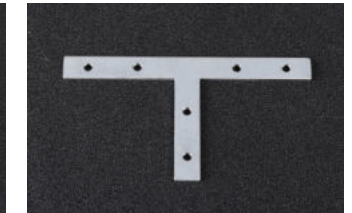

T
 100mm*10mm*2mm

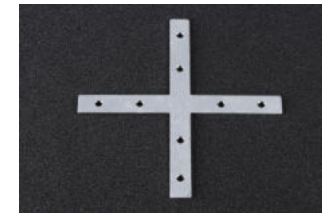

100mm*10mm*2mm

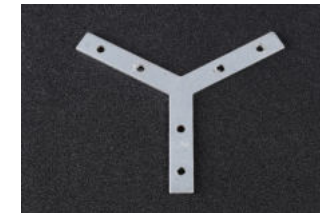

Y
 100mm*10mm*2mm



90
 50mm*10mm*2mm



90
 50mm*10mm*2mm

WIRE,CLIP,SPRING



CLIP



WIRE



SPRING



10CM SPRING

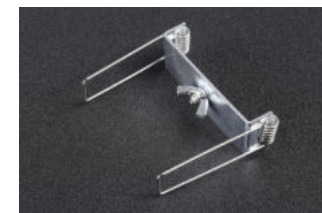

7CM SPRING



5CM SPRING



4CM SPRING



3CM SPRING